

*Fastening Systems Engineered For Performance™*

# **RIVET NUT INSERT CATALOG**

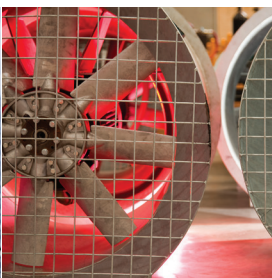
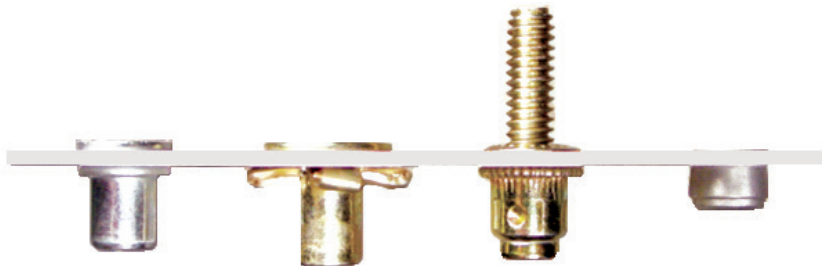

# TABLE OF CONTENTS

**PAGE 2-3**

About Us

**PAGE 4-5**

RIVET NUT Introduction

**PAGE 6**

Imperial/Inch Body Style Rivet Nuts

**PAGE 7**

CAL Large Flange Knurled Body Thin Wall Series

**PAGE 8**

CAK Small Flange Knurled Body Thin Wall Series

**PAGE 9**

CAH Half Hex Body Large Flange Thin Wall Series

**PAGE 10**

CA Heavy Duty Rivet Nut Flat Head Series

**PAGE 11**

CAO Small Flange Smooth Body Thin Wall Series

**PAGE 12**

FHK/FHL Large and Small Flange Full Hex Series

**PAGE 13**

CFW/CAW Diamond Knurled 360° Swaging Series

**PAGE 14**

CFT/CAT Knurled 360° Swaging Series

**PAGE 15**

CPB Prebulbed Slotted Body Series

**PAGE 16**

CPN Straight Shank Slotted Body Series

**PAGE 17**

CFH & CFHD Full Hex Body Series

**PAGE 18**

Metric Body Style Rivet Nuts

**PAGE 19**

**UPO & HUPO Stainless Large Flange Metric Series**

**PAGE 20**

UFO Countersunk Head and UKO Small Flange Metric Series

**PAGE 21**

HUPO & HUKO Large and Small Flange Hexagonal Metric Series



<b>PAGE 22</b>	UPO RS/UFO RS Large and CS Knurled Metric Series
<b>PAGE 23</b>	UKO and HUKO Imperial Thread Series - Stainless Steel
<b>PAGE 24</b>	CLM & CKM Large and Small Flange Knurled Metric Body Series
<b>PAGE 25-26</b>	Sherex CR/CRE Series, Sherex LOCSERT® and SEAL 2 Systems
<b>PAGE 27-30</b>	RIV-FLOAT® & RIV-FLOAT®-Short
<b>PAGE 31-33</b>	LARGE SIZE Rivet Nut Series
<b>PAGE 34</b>	Rivet Nut Studs
<b>PAGE 35-38</b>	NAS/MS Flat Head and Countersunk Head Styles
<b>PAGE 39-40</b>	CAL and CAH Rivet Nut Kits
<b>PAGE 41</b>	RIVET NUT Hand Tools
<b>PAGE 42</b>	RIVET NUT Pneumatic Spin - Spin Tools
<b>PAGE 43-44</b>	Hydro-Pneumatic FLEX-5 Tool and MS 100 Rivet Nut Tool
<b>PAGE 45</b>	Hydro-Pneumatic FLEX-18 Tool
<b>PAGE 46</b>	Value Propositions
<b>PAGE 47</b>	Testing Methods
<b>PAGE 48</b>	Sherex Product Matrix
<b>PAGE 49-50</b>	Sherex Product Showcase
<b>PAGE 51</b>	Sherex Website and 3D Models
<b>PAGE 52</b>	Decimal Equivalents and Drill Size Chart
<b>PAGE 53</b>	Additional Sherex Product Lines



## COMPANY OVERVIEW

### ABOUT SHEREX

Sherex Industries was founded in 1979 in Buffalo, NY primarily serving the Automotive and Fluid Power markets. In 2004, the rivet nut division was spun off, and became Sherex Fastening Solutions. Throughout our 35+ year history, we've remained steadfast in our mission to deliver high quality fastening solutions at the lowest total installed cost. We've expanded and improved our offerings and services by creating proprietary products, forming strategic partnerships, and establishing world-class production facilities and customer support centers in Taiwan, Mexico, and Akron, Ohio.

We've assembled a team of experienced, knowledgeable engineering and technical sales professionals that are dedicated to exceeding our customers' needs by collaborating to create customized, application-specific solutions.



### GLOBAL PRESENCE

Sherex provides service and support to our customers around the world through a network of sales offices, technical support centers, distribution hubs, and manufacturing facilities. We are a partner in the A-FAS group, a consortium of 9 companies across Europe, Asia, and North America that work together to provide a comprehensive range of products, tools, automation, and customer support worldwide to our customers.

**AUTORIV®**

**Sherex Fastening Solutions®**

**Sherex Headquarters**  
Tonawanda, NY

**MDS**  
Fastening  
Systems

**Sherex Akron**

**Sherex Mexico**

**DEJOND**  
METAL MATTERS

**Sherex Taiwan**

**MANUFACTURING  
FACILITIES  
&  
QUALITY  
ASSURANCE**

## WORLD CLASS MANUFACTURING FACILITIES

Sherex has two strategically-located, ISO certified manufacturing facilities in Chungli City, Taiwan, and Akron, Ohio that produce a wide variety of fasteners.

### SHEREX TAIWAN



Sherex Taiwan specializes in using cold forming technology to produce rivet nuts, clinch nuts, and specialty designs in a high volume production environment. We are also capable of machining parts for production and application development.

### SHEREX AKRON



Sherex Akron manufactures MS/NAS fasteners and other specialty parts using cold forming and machining technologies. Our small batch production capabilities allow us to offer reduced lead times and low minimum order quantities. Cage Codes 7EK30 and 4JQL4.

## UNSURPASSED QUALITY

Each Sherex manufacturing facility is led by a team of seasoned engineering professionals charged with ensuring all products meet stringent quality requirements. Our facilities are certified to AS9100, ISO 9001:2008, ISO 14001, ISO/TS 16949, and ISO 17025. The Sherex Quality Management System, and our use of SPC (Statistical Process Control) ensures that all of our products are manufactured using reliable, repeatable, and compliant processes.

We also use tensile testing, accelerated corrosion salt spray testing machines, torque testing, standard measurement and gauging equipment, and optical sorting machines to ensure world class product quality. Please contact us for more information on our quality certifications and processes.

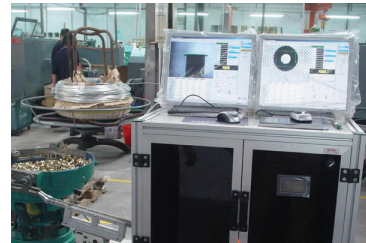

# RIVET NUT INTRODUCTION

## RIVET NUT INTRO

### RIVET NUT INTRODUCTION

Blind Rivet Nuts provide load-bearing threads in thin sheet materials that are too thin for a tapped thread. Blind Rivet Nuts also are used when an application has little or no access to the backside as they can be installed from the front side of the work piece.

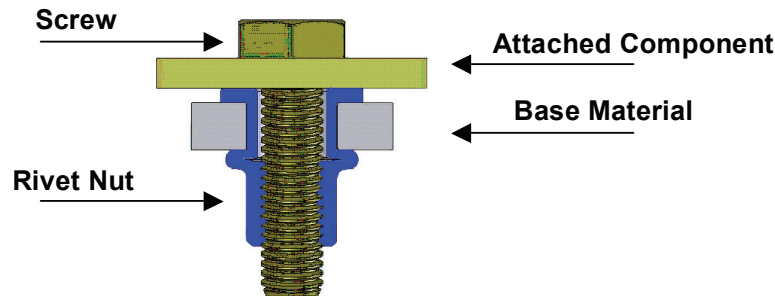

### ADVANTAGES OF RIVET NUTS

- Rivet Nuts provide a strong thread in thin materials that cannot be tapped.
- Rivet Nuts can be installed from one side of the work piece, also known as a "Blind Application."
- Rivet Nuts are ideal when easy disassembly and reassembly of products is required.
- Rivet Nuts can be installed in many different kinds of material including steel, plastic and fiberglass.
- Once Rivet Nuts are installed, additional components with threaded fasteners can be attached.
- Rivet Nuts do not need to be welded to the base material.
- Prepainted material will not be damaged during the Rivet Nut installation process.
- Rivet Nuts are available in many different styles & materials for many different types of applications.

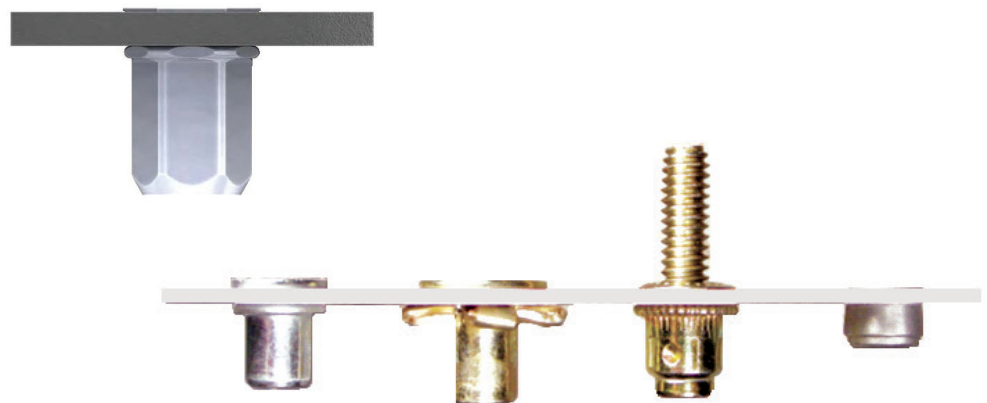

### APPLICATIONS: INDUSTRIES

Rivet nuts are used in a variety of industries:

- Automotive
- HVAC
- Aerospace and Defense
- Agricultural Equipment
- Construction Equipment
- General Industrial
- Electronics
- Medical
- Railways
- Heavy Truck (Class 8)
- Solar
- Wind Power

### EXAMPLES OF RIVET NUT APPLICATIONS

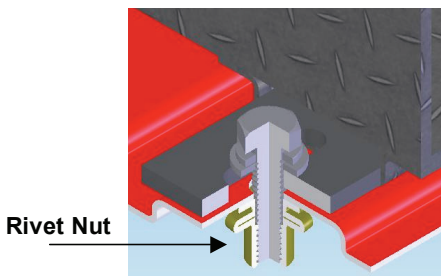

After Market Vehicle Retrofit – Tool Box



Vehicle Accessory – Pickup Side Rail

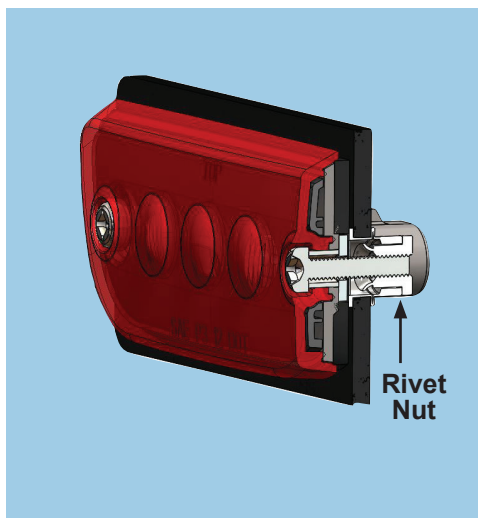

Automotive – Light Assembly  
Rivet Nut

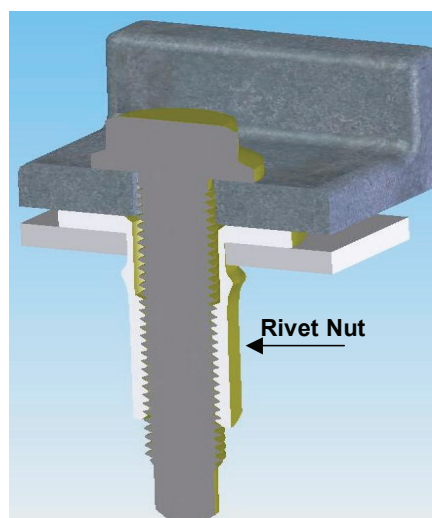

Agriculture Equipment – High Strength  
Rivet Nut

# IMPERIAL/INCH BODY STYLE RIVET NUTS

## IMPERIAL/ INCH BODY STYLE RIVET NUTS



- Imperial/Inch body styles are designed to be placed in fractional or common inch drill/punch hole sizes.
- They are the most common styles used in the American marketplace.
- Most of the inch/imperial body styles are available with metric threads.
- All parts are manufactured by Sherex Taiwan, our ISO/TS 16949 and ISO 14001 certified production facility, and Sherex Akron, our AS9100 and ISO 9001:2008 certified facility.
- Special designs are available to meet customer specific requirements. Contact Sherex with your application information.

### CATALOG ATTRIBUTES - INCH BODY STYLE

<b>Grip Range</b>	Material Thickness	<b>D(A/F)</b>	Diameter Across Flats
<b>L</b>	Length	<b>IL</b>	Installed Length
<b>HD</b>	Head Diameter	<b>LB</b>	Length Closed End
<b>HT</b>	Head Thickness	<b>ILB</b>	Installed Length Closed End
<b>D</b>	Diameter	<b>ITD</b>	Installed Thread Depth



# CAL LARGE FLANGE KNURLED BODY THIN WALL SERIES

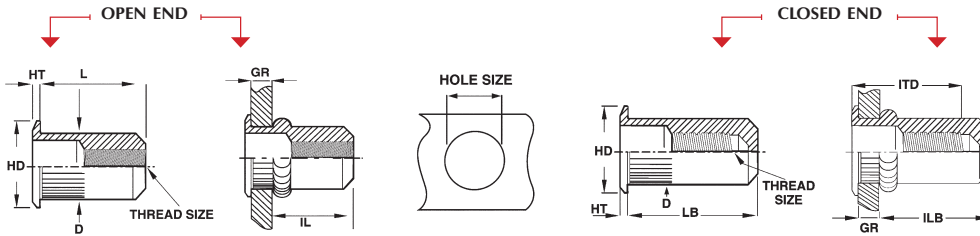

## CAL SERIES



### UNIFIED THREAD (UNIT - INCHES)

Part Number (Steel)	Thread Size	Grip Range		L	HD	HT	D	IL	LB	ILB	ITD	Hole Size
		Min.	Max.									
CAL2-0632-080	6-32 UNC	.020	.080	.420	.390	.030	.265	.305	.740	.640	.610	+.006/- .000
CAL2-0632-130	6-32 UNC	.080	.130	.470	.390	.030	.265	.305	.740	.580	.670	.266
CAL2-0832-080	8-32 UNC	.020	.080	.420	.390	.030	.265	.305	.740	.640	.610	.266
CAL2-0832-130	8-32 UNC	.080	.130	.470	.390	.030	.265	.305	.740	.580	.670	.266
CAL2-1024-130	10-24 UNC	.020	.130	.475	.415	.030	.296	.315	.990	.845	.730	.297
CAL2-1024-225	10-24 UNC	.130	.225	.585	.415	.030	.296	.315	.990	.735	.840	.297
CAL2-1032-130	10-32 UNF	.020	.130	.475	.415	.030	.296	.315	.990	.845	.730	.297
CAL2-1032-225	10-32 UNF	.130	.225	.585	.415	.030	.296	.315	.990	.735	.840	.297
CAL2-2520-165	1/4-20 UNC	.027	.165	.580	.500	.030	.390	.380	1.190	1.005	.895	.391
CAL2-2520-260	1/4-20 UNC	.165	.260	.680	.500	.030	.390	.380	1.190	.905	1.035	.391
CAL2-2528-165	1/4-28 UNF	.027	.165	.580	.500	.030	.390	.380	1.190	1.005	.895	.391
CAL2-2528-260	1/4-28 UNF	.165	.260	.680	.500	.030	.390	.380	1.190	.905	1.035	.391
CAL2-3118-150	5/16-18 UNC	.027	.150	.690	.685*	.035	.530	.470	1.390	1.175	.995	.531
CAL2-3118-312	5/16-18 UNC	.150	.312	.805	.685*	.035	.530	.425	1.390	1.025	1.120	.531
CAL2-3124-150	5/16-24 UNF	.027	.150	.690	.685*	.035	.530	.470	1.390	1.175	.995	.531
CAL2-3124-312	5/16-24 UNF	.150	.312	.805	.685*	.035	.530	.425	1.390	1.025	1.120	.531
CAL2-3716-150	3/8-16 UNC	.027	.150	.690	.685*	.035	.530	.470	1.390	1.175	.995	.531
CAL2-3716-312	3/8-16 UNC	.150	.312	.805	.685*	.035	.530	.425	1.390	1.025	1.120	.531
CAL2-3724-150	3/8-24 UNF	.027	.150	.690	.685*	.035	.530	.470	1.390	1.175	.995	.531
CAL2-3724-312	3/8-24 UNF	.150	.312	.805	.685*	.035	.530	.425	1.390	1.025	1.120	.531
CAL2-5013-200	1/2-13 UNC	.063	.200	1.150	.865*	.047	.685	.850	2.365	2.070	1.505	.688
CAL2-5013-350	1/2-13 UNC	.200	.350	1.300	.865*	.047	.685	.850	2.365	1.920	1.505	.688

- The CAL series has a large flange to provide increased strength in punched and drilled holes.
- Knurled body provides a higher resistance to spin out when installed in soft materials.

### METRIC THREAD (UNIT - MILLIMETERS)

Part Number (Steel)	Thread Size	Grip Range		L	HD	HT	D	IL	LB	ILB	ITD	Hole Size
		Min.	Max.									
CAL2-470-2.0	M4x0.7 ISO	0.50	2.00	10.68	9.91	0.76	6.73	7.75	18.80	16.26	15.49	6.75
CAL2-470-3.3	M4x0.7 ISO	2.00	3.30	11.94	9.91	0.76	6.73	7.75	18.80	14.73	17.02	6.75
CAL2-580-3.3	M5x0.8 ISO	0.50	3.30	12.07	10.54	0.76	7.52	8.00	25.15	21.46	18.54	7.60
CAL2-580-5.7	M5x0.8 ISO	3.30	5.70	14.86	10.54	0.76	7.52	8.00	25.15	18.67	21.34	7.60
CAL2-610-4.2	M6x1.0 ISO	0.70	4.20	14.73	12.70	0.76	9.91	9.65	30.23	25.53	22.73	10.00
CAL2-610-6.6	M6x1.0 ISO	4.20	6.60	17.27	12.70	0.76	9.91	9.65	30.23	22.99	26.29	10.00
CAL2-8125-3.8	M8x1.25 ISO	0.70	3.80	17.53	17.40*	0.89	13.46	11.94	35.31	29.85	25.27	13.50
CAL2-8125-7.9	M8x1.25 ISO	3.80	7.90	20.45	17.40*	0.89	13.46	10.80	35.31	26.04	28.45	13.50
CAL2-1015-3.8	M10x1.5 ISO	0.70	3.80	17.53	17.40*	0.89	13.46	11.94	35.31	29.85	25.27	13.50
CAL2-1015-7.9	M10x1.5 ISO	3.80	7.90	20.45	17.40*	0.89	13.46	10.80	35.31	26.04	28.45	13.50
CAL2-12175-5.1	M12x1.75 ISO	1.60	5.10	29.21	21.97*	1.19	17.40	21.59	60.07	52.58	38.23	17.45
CAL2-12175-8.9	M12x1.75 ISO	5.10	8.90	33.02	21.97*	1.19	17.40	21.59	60.07	48.77	38.23	17.45

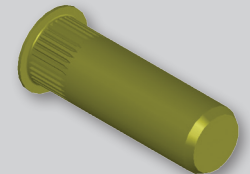

CLOSED END

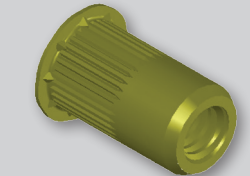

WEDGE HEAD

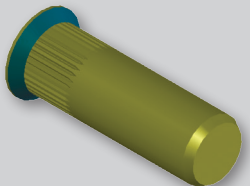

SEALED HEAD

### PART NUMBERING SYSTEM

#### CAL Specifications

**Material:**  
Steel 1008/1010  
Stainless Steel 302\*  
Aluminum 5056

#### RoHS Compliant Finishes:

Zinc Plated-Yellow Trivalent Chromate per Sherex SFS-01-001, SC2  
Zinc Plated-Clear Trivalent Chromate per Sherex SFS-01-001

#### Part Number

Example: CAL2-2520-165

CAL	2	2520	165	( )
Product Style	Material	Thread Size	Grip Range	Empty-Open End
Large Flange	1-Stainless Steel			B-Closed End
Knurled Body	2-Steel			T-Clear Trivalent
Thin Wall Series	3-Aluminum			W-Wedge Head
				S-Sealed

*Special finish or material available upon request*

\*Contact Sherex for exact product dimensions in Stainless Steel.

Grip range can be affected by parent material and hole size. Sherex recommends trial installations to determine the proper grip range for the application. Contact Sherex for details.

CAL style rivet nuts are available in sealed, closed end, and wedge head designs by special order. Other specials available upon request. Contact Sherex for test data.

#### INSTALLATION TOOLING

CAL Series can be installed with our Hand Tools, Pneumatic Tools, and Hydro-Pneumatic Tools. For additional tooling information see pages 41-45.

Sherex rivet nuts are compatible with the following hardware:

**GRADE 2, GRADE 5, CLASS 8.8 and CLASS 9.8**

Please contact Sherex when using other grade fasteners.

# CAK SMALL FLANGE KNURLED BODY THIN WALL SERIES

## CAK SERIES



- The CAK series has a small flange for a near flush installation.
- Knurled body provides a higher resistance to spin out when installed in soft materials.

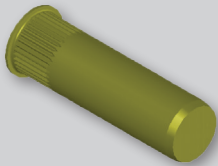

CLOSED END

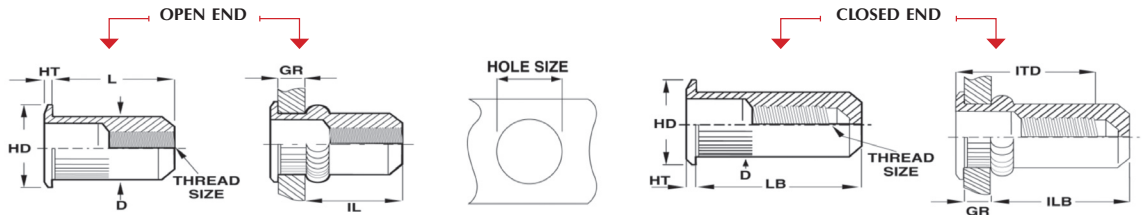

### UNIFIED THREAD (UNIT - INCHES)

Part Number (Steel)	Thread Size	Grip Range		L ± .015	HD ±.010 ±.015*	HT ± .002	D Max.	IL Max.	LB ± .015	ILB Max.	ITD Ref.	Hole Size +.006/- .000
		Min.	Max.									
CAK2-0632-080	6-32 UNC	.020	.080	.420	.310	.019	.265	.305	.740	.640	.610	.266
CAK2-0632-130	6-32 UNC	.080	.130	.470	.310	.019	.265	.305	.740	.580	.670	.266
CAK2-0832-080	8-32 UNC	.020	.080	.420	.310	.019	.265	.305	.740	.640	.610	.266
CAK2-0832-130	8-32 UNC	.080	.130	.470	.310	.019	.265	.305	.740	.580	.670	.266
CAK2-1024-130	10-24 UNC	.020	.130	.475	.340	.019	.296	.315	.990	.845	.730	.297
CAK2-1024-225	10-24 UNC	.130	.225	.585	.340	.019	.296	.315	.990	.735	.840	.297
CAK2-1032-130	10-32 UNF	.020	.130	.475	.340	.019	.296	.315	.990	.845	.730	.297
CAK2-1032-225	10-32 UNF	.130	.225	.585	.340	.019	.296	.315	.990	.735	.840	.297
CAK2-2520-165	1/4-20 UNC	.027	.165	.580	.455	.022	.390	.380	1.190	1.005	.895	.391
CAK2-2520-260	1/4-20 UNC	.165	.260	.680	.455	.022	.390	.380	1.190	.905	1.035	.391
CAK2-2528-165	1/4-28 UNF	.027	.165	.580	.455	.022	.390	.380	1.190	1.005	.895	.391
CAK2-2528-260	1/4-28 UNF	.165	.260	.680	.455	.022	.390	.380	1.190	.905	1.035	.391
CAK2-3118-150	5/16-18 UNC	.027	.150	.690	.595*	.022	.530	.470	1.390	1.175	.995	.531
CAK2-3118-312	5/16-18 UNC	.150	.312	.805	.595*	.022	.530	.425	1.390	1.025	1.120	.531
CAK2-3124-150	5/16-24 UNF	.027	.150	.690	.595*	.022	.530	.470	1.390	1.175	.995	.531
CAK2-3124-312	5/16-24 UNF	.150	.312	.805	.595*	.022	.530	.425	1.390	1.025	1.120	.531
CAK2-3716-150	3/8-16 UNC	.027	.150	.690	.595*	.022	.530	.470	1.390	1.175	.995	.531
CAK2-3716-312	3/8-16 UNC	.150	.312	.805	.595*	.022	.530	.425	1.390	1.025	1.120	.531
CAK2-3724-150	3/8-24 UNF	.027	.150	.690	.595*	.022	.530	.470	1.390	1.175	.995	.531
CAK2-3724-312	3/8-24 UNF	.150	.312	.805	.595*	.022	.530	.425	1.390	1.025	1.120	.531

### METRIC THREAD (UNIT - MILLIMETERS)

Part Number (Steel)	Thread Size	Grip Range		L ± .38	HD ±.25 ±.38*	HT ± .05	D Max.	IL Max.	LB ± .38	ILB Max.	ITD Ref.	Hole Size +.15/- .000
		Min.	Max.									
CAK2-470-2.0	M4x0.7 ISO	0.50	2.00	10.67	7.87	0.48	6.73	7.75	18.80	16.26	15.49	6.75
CAK2-470-3.3	M4x0.7 ISO	2.00	3.30	11.94	7.87	0.48	6.73	7.75	18.80	14.73	17.02	6.75
CAK2-580-3.3	M5x0.8 ISO	0.50	3.30	12.07	8.64	0.48	7.52	8.00	25.15	21.46	18.54	7.60
CAK2-580-5.7	M5x0.8 ISO	3.30	5.70	14.86	8.64	0.48	7.52	8.00	25.15	18.67	21.34	7.60
CAK2-610-4.2	M6x1.0 ISO	0.70	4.20	14.73	11.56	0.55	9.91	9.65	30.23	25.53	22.73	10.00
CAK2-610-6.6	M6x1.0 ISO	4.20	6.60	17.27	11.56	0.55	9.91	9.65	30.23	22.99	26.29	10.00
CAK2-8125-3.8	M8x1.25 ISO	0.70	3.80	17.53	15.11*	0.55	13.46	11.94	35.31	29.85	25.27	13.50
CAK2-8125-7.9	M8x1.25 ISO	3.80	7.90	20.45	15.11*	0.55	13.46	10.80	35.31	26.04	28.45	13.50
CAK2-1015-3.8	M10x1.5 ISO	0.70	3.80	17.53	15.11*	0.55	13.46	11.94	35.31	29.85	25.27	13.50
CAK2-1015-7.9	M10x1.5 ISO	3.80	7.90	20.45	15.11*	0.55	13.46	10.80	35.31	26.04	28.45	13.50

### PART NUMBERING SYSTEM

#### CAK Specifications

##### Material:

Steel 1008/1010  
Stainless Steel 302\*  
Aluminum 5056

##### RoHS Compliant Finishes:

Zinc Plated-Yellow Trivalent Chromate  
per Sherex SFS-01-001, SC2  
Zinc Plated-Clear Trivalent Chromate  
per Sherex SFS-01-001

#### Part Number

Example: CAK2-2520-165

CAK	2	2520	165	( )
Product Style	Material	Thread Size	Grip Range	Empty-Open End
Small Flange	1-Stainless Steel			B-Closed End
Knurled Body	2-Steel			T-Clear Trivalent
Thin Wall Series	3-Aluminum			

*Special finish or material available upon request*

\*Contact Sherex for exact product dimensions in Stainless Steel.

Grip range can be affected by parent material and hole size. Sherex recommends trial installations to determine the proper grip range for the application.

Contact Sherex for details.

CAK style rivet nuts are available in closed end designs. Other specials available upon request.

Contact Sherex for test data.

#### INSTALLATION TOOLING

CAK Series can be installed with our Hand Tools, Pneumatic Tools, and Hydro-Pneumatic Tools.

For additional tooling information see pages 41-45.

Sherex rivet nuts are compatible with the following hardware:

**GRADE 2, GRADE 5, CLASS 8.8 and CLASS 9.8**

Please contact Sherex when using other grade fasteners.

# CAH HALF HEX BODY LARGE FLANGE THIN WALL SERIES

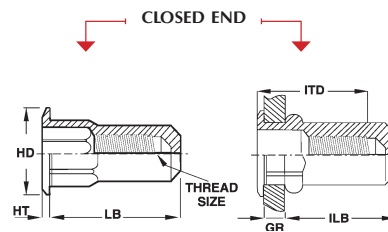
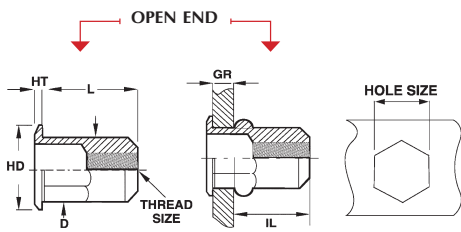

**CAH  
SERIES**

## UNIFIED THREAD (UNIT - INCHES)

Part Number (Steel)	Thread Size	Grip Range		L ± .015	HD ±.010 ±.025*	HT ± .003	D (A/F) Max.	IL Max.	LB ± .015	ILB Max.	ITD Ref.	Hole Size (A/F) +.004/-0.000
		Min.	Max.									
CAH2-0632-080	6-32 UNC	.020	.080	.385	.375	.027	.249	.295	.740	.640	.575	.250
CAH2-0632-130	6-32 UNC	.080	.130	.435	.375	.027	.249	.295	.740	.580	.640	.250
CAH2-0832-080	8-32 UNC	.020	.080	.385	.375	.027	.249	.295	.740	.640	.575	.250
CAH2-0832-130	8-32 UNC	.080	.130	.435	.375	.027	.249	.295	.740	.580	.640	.250
CAH2-1024-130	10-24 UNC	.020	.130	.435	.390	.027	.280	.275	1.030	.845	.695	.281
CAH2-1024-225	10-24 UNC	.130	.225	.535	.390	.027	.280	.275	1.030	.735	.805	.281
CAH2-1032-130	10-32 UNF	.020	.130	.435	.390	.027	.280	.275	1.030	.845	.695	.281
CAH2-1032-225	10-32 UNF	.130	.225	.535	.390	.027	.280	.275	1.030	.735	.805	.281
CAH2-2520-165	1/4-20 UNC	.027	.165	.585	.510	.030	.374	.400	1.190	1.015	.945	.375
CAH2-2520-260	1/4-20 UNC	.165	.260	.685	.510	.030	.374	.400	1.190	.915	1.085	.375
CAH2-2528-165	1/4-28 UNF	.027	.165	.585	.510	.030	.374	.400	1.190	1.015	.945	.375
CAH2-2528-260	1/4-28 UNF	.165	.260	.685	.510	.030	.374	.400	1.190	.915	1.085	.375
CAH2-3118-150	5/16-18 UNC	.027	.150	.685	.655*	.035	.499	.530	1.445	1.235	1.045	.500
CAH2-3118-312	5/16-18 UNC	.150	.312	.845	.655*	.035	.499	.515	1.445	1.220	1.170	.500
CAH2-3124-150	5/16-24 UNF	.027	.150	.685	.655*	.035	.499	.530	1.445	1.235	1.045	.500
CAH2-3124-312	5/16-24 UNF	.150	.312	.845	.655*	.035	.499	.515	1.445	1.220	1.170	.500
CAH2-3716-150	3/8-16 UNC	.027	.150	.685	.655*	.035	.499	.530	1.445	1.235	1.045	.500
CAH2-3716-312	3/8-16 UNC	.150	.312	.845	.655*	.035	.499	.515	1.445	1.220	1.170	.500
CAH2-3724-150	3/8-24 UNF	.027	.150	.685	.655*	.035	.499	.530	1.445	1.235	1.045	.500
CAH2-3724-312	3/8-24 UNF	.150	.312	.845	.655*	.035	.499	.515	1.445	1.220	1.170	.500



- The CAH series offers a semi hex body for excellent resistance to spin out in the hole.

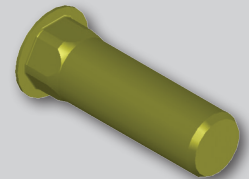

CLOSED END

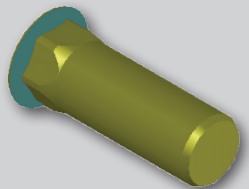

SEALED HEAD

## METRIC THREAD (UNIT - MILLIMETERS)

Part Number (Steel)	Thread Size	Grip Range		L ± .38	HD ±.25 ±.64*	HT ± .08	D (A/F) Max.	IL Max.	LB ± .38	ILB Max.	ITD Ref.	Hole Size (A/F) +.10/-0.000
		Min.	Max.									
CAH2-470-2.0	M4x0.7 ISO	0.50	2.00	9.78	9.53	0.68	6.35	7.49	18.80	16.26	14.61	6.35
CAH2-470-3.3	M4x0.7 ISO	2.00	3.30	11.05	9.53	0.68	6.35	7.49	18.80	14.73	16.26	6.35
CAH2-580-3.3	M5x0.8 ISO	0.50	3.30	11.05	9.91	0.68	7.10	6.99	26.16	21.46	17.65	7.14
CAH2-580-5.7	M5x0.8 ISO	3.30	5.70	13.59	9.91	0.68	7.10	6.99	26.16	18.67	20.45	7.14
CAH2-610-4.2	M6x1.0 ISO	0.70	4.20	14.86	12.96	0.76	9.50	10.16	30.23	25.78	24.00	9.53
CAH2-610-6.6	M6x1.0 ISO	4.20	6.60	17.40	12.96	0.76	9.50	10.16	30.23	23.24	27.56	9.53
CAH2-8125-3.8	M8x1.25 ISO	0.70	3.80	17.40	16.64*	0.89	12.70	13.46	36.70	31.37	26.54	12.70
CAH2-8125-7.9	M8x1.25 ISO	3.80	7.90	21.46	16.64*	0.89	12.70	13.08	36.70	30.99	29.72	12.70
CAH2-1015-3.8	M10x1.5 ISO	0.70	3.80	17.40	16.64*	0.89	12.70	13.46	36.70	31.37	26.54	12.70
CAH2-1015-7.9	M10x1.5 ISO	3.80	7.90	21.46	16.64*	0.89	12.70	13.08	36.70	30.99	29.72	12.70

## PART NUMBERING SYSTEM

### CAH Specifications

#### Material:

Steel 1008/1010  
Stainless Steel 302\*  
Aluminum 5056

#### RoHS Compliant Finishes:

Zinc Plated-Yellow Trivalent Chromate  
per Sherex SFS-01-001, SC2  
Zinc Plated-Clear Trivalent Chromate  
per Sherex SFS-01-001

### Part Number

Example: CAH2-2520-165

CAH	2	2520	165	( )
Product Style	Material	Thread Size	Grip Range	Empty-Open End
Semi Hex	1-Stainless Steel			B-Closed End
Thin Wall Series	2-Steel			T-Clear Trivalent
	3-Aluminum			

*Special finish or material available upon request*

\*Contact Sherex for exact product dimensions in Stainless Steel.

Grip range can be affected by parent material and hole size. Sherex recommends trial installations to determine the proper grip range for the application.

Contact Sherex for details.

CAH style rivet nuts are available in sealed head and closed end designs. Other specials available upon request.

Contact Sherex for test data.

### INSTALLATION TOOLING

CAH Series can be installed with our Hand Tools, Pneumatic Tools, and Hydro-Pneumatic Tools.

For additional tooling information see pages 41-45.

Sherex rivet nuts are compatible with the following hardware:

**GRADE 2, GRADE 5, CLASS 8.8 and CLASS 9.8**

Please contact Sherex when using other grade fasteners.

# CA HEAVY DUTY RIVET NUT FLAT HEAD SERIES

## CA SERIES



- The CA series offers a thick head and thick collapse chamber wall thickness for heavy duty applications.
- Available with a countersunk head style for a flush installation.
- Available in a keyed head style for resistance spin out.

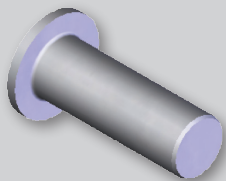

CLOSED END

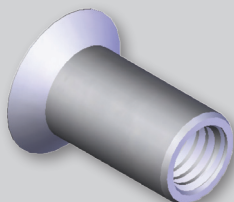

COUNTERSUNK HEAD

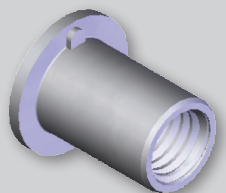

KEYED HEAD

Sherex manufactures  
NAS 1329 and NAS  
1330 style Rivet Nuts.  
See page 35 for details.

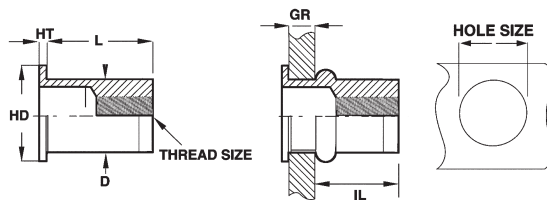

### UNIFIED THREAD (UNIT - INCHES)

Part Number (Steel)	Thread Size	Grip Range		L ± .015	HD ± .015	HT Nom.	D +.000/-.004	IL Ref.	Hole Size
		Min.	Max.						
CA-0440S-060	4-40 UNC	.010	.060	.345	.270	.025	.155	.230	.155-.157
CA-0440S-085	4-40 UNC	.060	.085	.370	.270	.025	.155	.230	.155-.157
CA-0440S-110	4-40 UNC	.085	.100	.400	.270	.025	.155	.230	.155-.157
CA-0632S-075	6-32 UNC	.010	.075	.438	.325	.032	.189	.300	.189-.193
CA-0632S-120	6-32 UNC	.075	.120	.500	.325	.032	.189	.315	.189-.193
CA-0632S-160	6-32 UNC	.120	.160	.500	.325	.032	.189	.270	.189-.193
CA-0832S-075	8-32 UNC	.010	.075	.438	.357	.032	.221	.300	.221-.226
CA-0832S-120	8-32 UNC	.075	.120	.500	.357	.032	.221	.315	.221-.226
CA-0832S-160	8-32 UNC	.120	.160	.500	.357	.032	.221	.270	.221-.226
CA-1024S-080	10-24 UNC	.010	.080	.531	.406	.038	.250	.380	.250-.256
CA-1024S-130	10-24 UNC	.080	.130	.594	.406	.038	.250	.390	.250-.256
CA-1024S-180	10-24 UNC	.130	.180	.641	.406	.038	.250	.390	.250-.256
CA-1032S-080	10-32 UNF	.010	.080	.531	.406	.038	.250	.380	.250-.256
CA-1032S-130	10-32 UNF	.080	.130	.594	.406	.038	.250	.390	.250-.256
CA-1032S-180	10-32 UNF	.130	.180	.641	.406	.038	.250	.390	.250-.256
CA-2520S-080	1/4-20 UNC	.020	.080	.625	.475	.058	.332	.450	.332-.338
CA-2520S-140	1/4-20 UNC	.080	.140	.687	.475	.058	.332	.450	.332-.338
CA-2520S-200	1/4-20 UNC	.140	.200	.750	.475	.058	.332	.450	.332-.338
CA-3118S-125	5/16-18 UNC	.030	.125	.750	.665	.062	.413	.505	.413-.423
CA-3118S-200	5/16-18 UNC	.125	.200	.875	.665	.062	.413	.555	.413-.423
CA-3118S-275	5/16-18 UNC	.200	.275	.937	.655	.062	.413	.540	.413-.423
CA-3716S-115	3/8-16 UNC	.030	.115	.844	.781	.088	.490	.585	.490-.500
CA-3716S-200	3/8-16 UNC	.115	.200	.938	.781	.088	.490	.595	.490-.500
CA-3716S-285	3/8-16 UNC	.200	.285	1.031	.781	.088	.490	.605	.490-.500
CA-5013S-150	1/2-13 UNC	.050	.150	.906	.906	.085	.625	.605	.625-.635
CA-5013S-250	1/2-13 UNC	.150	.250	1.031	.906	.085	.625	.630	.625-.635
CA-5013S-350	1/2-13 UNC	.250	.350	1.141	.906	.085	.625	.640	.625-.635

### PART NUMBERING SYSTEM

#### CA Specifications

##### Material:

Steel 1008/1010/1110  
Non-Magnetic Stainless Steel 302  
Stainless Steel 430  
Aluminum 5056/6053

##### RoHS Compliant Finish:

Zinc Plated-Clear Trivalent Chromate  
per Sherex SFS-01-001

#### Part Number

Example: CA-2520S-080

CA	2520	Material	( )	080
Product Style	Thread Size	S-Steel	Empty-Open End	Grip Range
Heavy Duty		A-Aluminum	B-Closed End	
Large Flange		SS-Stainless Steel 430	T-Clear Trivalent	
Smooth Shank		NM-Stainless Steel 302		
		NM318-Satinless Steel 316		

Special finish or material available upon request

Grip range can be affected by parent material and hole size. Sherex recommends trial installations to determine the proper grip range for the application.

Contact Sherex for details.

CA style rivet nuts are available in closed end, keyed, and countersunk head designs. Other specials available upon request.

Contact Sherex for test data.

#### INSTALLATION TOOLING

CA Series can be installed with our Hand Tools, and Hydro-Pneumatic Tools.

For additional tooling information see pages 41-45.

Sherex rivet nuts are compatible with the following hardware:

**GRADE 2, GRADE 5, CLASS 8.8 and CLASS 9.8**

Please contact Sherex when using other grade fasteners.

# CAO SMALL FLANGE SMOOTH BODY THIN WALL SERIES

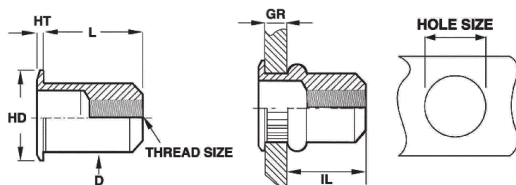

**CAO  
SERIES**



- The CAO series offers body diameters that will fit in common hole sizes.
- The small flange head also allows for near flush installations.

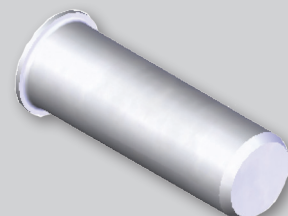

**CLOSED END**

## UNIFIED THREAD (UNIT - INCHES)

Part Number (Steel)	Thread Size	Grip Range		L ± .015	HD ± .010 ±.015*	HT ± .003	D Max.	IL Max.	Hole Size +.006/-.000
		Min.	Max.						
CAO2-0632-080	6-32 UNC	.020	.080	.385	.295	.018	.249	.315	.250
CAO2-0832-080	8-32 UNC	.020	.080	.385	.295	.018	.249	.315	.250
CAO2-1024-130	10-24 UNC	.020	.130	.440	.320	.020	.280	.330	.281
CAO2-1032-130	10-32 UNF	.020	.130	.440	.320	.020	.280	.330	.281
CAO2-2520-165	1/4-20 UNC	.030	.165	.580	.425	.022	.374	.440	.375
CAO2-2528-165	1/4-28 UNF	.030	.165	.580	.425	.022	.374	.440	.375
CAO2-3118-200	5/16-18 UNC	.040	.200	.690	.560*	.022	.499	.540	.500
CAO2-3124-200	5/16-24 UNF	.040	.200	.690	.560*	.022	.499	.540	.500
CAO2-3716-200	3/8-16 UNC	.040	.200	.690	.560*	.022	.499	.540	.500
CAO2-3724-200	3/8-24 UNF	.040	.200	.690	.560*	.022	.499	.540	.500

## METRIC THREAD (UNIT - MILLIMETERS)

Part Number (Steel)	Thread Size	Grip Range		L ± .38	HD ± .25 ±.38*	HT ± .08	D Max.	IL Max.	Hole Size +.15/-.000
		Min.	Max.						
CAO2-470-2.0	M4x0.7 ISO	0.50	2.00	9.78	7.49	0.46	6.32	8.00	6.40
CAO2-580-3.3	M5x0.8 ISO	0.50	3.30	11.18	8.13	0.51	7.11	8.38	7.20
CAO2-610-4.2	M6x1.0 ISO	0.76	4.20	14.73	10.80	0.56	9.50	11.18	9.60
CAO2-8125-5.1	M8x1.25 ISO	1.02	5.10	17.53	14.22*	0.56	12.67	13.72	12.70
CAO2-1015-5.1	M10x1.5 ISO	1.02	5.10	17.53	14.22*	0.56	12.67	13.72	12.70

## PART NUMBERING SYSTEM

### CAO Specifications

#### Material:

Steel 1008/1010  
Aluminum 5056

#### RoHS Compliant Finishes:

Inch: Zinc Plated-Clear Trivalent Chromate  
per Sherex SFS-01-001

Metric: Zinc Plated-Yellow Trivalent Chromate  
per Sherex SFS-01-001, SC2

### Part Number

Example: CAO2-2520-165

CAO	2	2520	165	( )
Product Style	Material	Thread Size	Grip Range	Empty-Open End
Low Profile	2-Steel			B-Closed End
Smooth Shank	3-Aluminum			T-Clear Trivalent
Thin Wall Series				

*Special finish or material available upon request*

Grip range can be affected by parent material and hole size. Sherex recommends trial installations to determine the proper grip range for the application.  
Contact Sherex for details.  
Contact Sherex for test data.

### INSTALLATION TOOLING

CAO Series can be installed with our Hand Tools, Pneumatic Tools, and Hydro-Pneumatic Tools.  
For additional tooling information see pages 41-45.

Sherex rivet nuts are compatible with the following hardware:

**GRADE 2, GRADE 5, CLASS 8.8 and CLASS 9.8**

Please contact Sherex when using other grade fasteners.

# FHK/FHL FULL HEX SMALL AND LARGE FLANGE SERIES

## FHK/ FHL SERIES

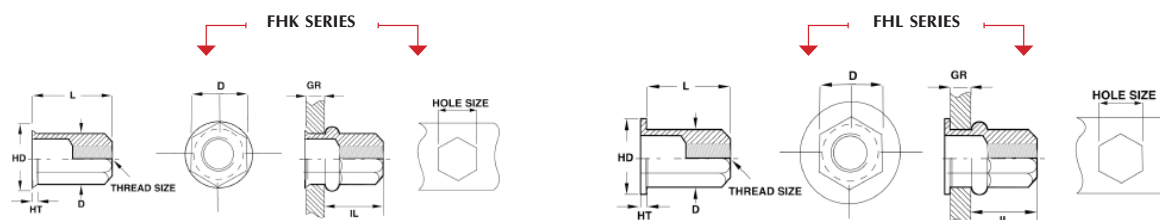

- The FHK/FHL series provides increased spin out resistance over round body and half hex body rivet nuts.
- Proven to meet Class 8 and Grade 5 thread strength.

### FHK - SMALL FLANGE UNIFIED THREAD (UNIT - INCHES)

Part Number Inch - Steel	Thread Size	Grip Range		L ± .015	HD (A/F) ± .010 ± .015* ± .025**	HT ± .005 ± .008	D (A/F) Max.	IL Ref.	Hole Size (A/F) +.004/-.000
		Min.	Max.						
FHK2-2520-138	1/4-20 UNC	.039	.138	.673	.390	.016	.354	.469	.354
FHK2-2520-236		.138	.236	.772					
FHK2-2520-335		.236	.335	.870					
FHK2-3118-157	5/16-18 UNC	.031	.157	.787	.457	.016	.432	.535	.433
FHK2-3118-276		.157	.276	.913					
FHK2-3118-394		.276	.394	1.039					
FHK2-3716-177	3/8-16 UNC	.039	.177	.955	.559*	.025*	.511	.689	.512
FHK2-3716-295		.177	.295	1.053					
FHK2-3716-413		.295	.413	1.191					
FHK2-5013-177	1/2-13 UNC	.039	.177	1.215	.734**	.044*	.656	.866	.656

### FHK - SMALL FLANGE METRIC THREAD (UNIT - MILLIMETERS)

Part Number Metric - Steel	Thread Size	Grip Range		L ± .38	HD (A/F) ± .025 ± .038* ± .064**	HT ± 0.13 ± 0.18*	D (A/F) Max.	IL Ref.	Hole Size (A/F) +.10/-.000
		Min.	Max.						
FHK2-610-3.5	M6 X 1.0 ISO	1.0	3.5	17.10	9.92	.44	8.98	11.9	9.0
FHK2-610-6.0		3.5	6.0	19.60					
FHK2-610-8.5		6.0	8.5	22.10					
FHK2-8125-4.0	M8 X 1.25 ISO	0.8	4.0	20.00	11.60	.41	10.98	13.6	11.0
FHK2-8125-7.0		4.0	7.0	23.20					
FHK2-8125-10.0		7.0	10.0	26.40					
FHK2-1015-4.5	M10 X 1.5 ISO	1.0	4.5	24.25	14.20*	.64*	12.98	17.5	13.0
FHK2-1015-7.5		4.5	7.5	26.75					
FHK2-1015-10.5		7.5	10.5	30.25					
FHK2-12175-4.5	M12 X 1.75 ISO	1.0	4.5	30.85	18.65**	1.12*	16.65	22.0	16.66



- The FHK series has a small flange for a near flush installation.

### FHL - LARGE FLANGE UNIFIED THREAD (UNIT - INCHES)

Part Number Inch - Steel	Thread Size	Grip Range		L ± .015	HD (A/F) ± .014	HT ± .006	D (A/F) Max.	IL Ref.	Hole Size (A/F) +.004/-.000
		Min.	Max.						
FHL2-2520-138	1/4-20 UNC	.039	.138	.657	.511	.059	.354	.469	.354
FHL2-2520-236		.138	.236	.756					
FHL2-2520-335		.236	.335	.854					
FHL2-3118-157	5/16-18 UNC	.031	.157	.771	.630	.059	.432	.535	.433
FHL2-3118-276		.157	.276	.897					
FHL2-3118-394		.276	.394	1.020					
FHL2-3716-177	3/8-16 UNC	.039	.177	.910	.748	.079	.511	.689	.512
FHL2-3716-295		.177	.295	1.010					
FHL2-3716-413		.295	.413	1.140					
SHEREX Part Number Inch - Steel	Thread Size	Grip Range		L	HD (A/F)	HT	D (A/F)	IL	Hole Size (A/F)
LRGH2-5013-177	1/2-13 UNC	.039	.177	1.181	.959	.085	.656	.866	.656

### FHL - LARGE FLANGE METRIC THREAD (UNIT - MILLIMETERS)

Part Number Metric - Steel	Thread Size	Grip Range		L ± .38	HD (A/F) ± .35	HT ± .15	D (A/F) Max.	IL Ref.	Hole Size (A/F) +.10/-.000
		Min.	Max.						
FHL2-610-3.5	M6 X 1.0 ISO	1.0	3.5	16.70	13.00	1.50	8.98	11.9	9.0
FHL2-610-6.0		3.5	6.0	19.20					
FHL2-610-8.5		6.0	8.5	21.70					
FHL2-8125-4.0	M8 X 1.25 ISO	0.8	4.0	19.60	16.00	1.50	10.98	13.6	11.0
FHL2-8125-7.0		4.0	7.0	22.80					
FHL2-8125-10.0		7.0	10.0	26.00					
FHL2-1015-4.5	M10 X 1.5 ISO	1.0	4.5	23.10	19.00	2.00	12.98	17.5	13.0
FHL2-1015-7.5		4.5	7.5	25.60					
FHL2-1015-10.5		7.5	10.5	29.10					
Part Number Metric - Steel	Thread Size	Grip Range		L	HD (A/F)	HT	D (A/F)	IL	Hole Size (A/F)
LRGH2-12175-4.5	M12 X 1.75 ISO	1.0	4.5	30.00	24.36	2.16	16.65	22.0	16.66



- The FHL series has a large flange to provide increased strength in punched and drilled holes.

Material: Steel 108/1010

ROHS Compliant Finishes: Zinc plated – clear trivalent chromate per Sherex SFS-01-001

Sherex full hex rivet nuts are compatible with the following hardware:

GRADE 2, GRADE 5, CLASS 8.8 and CLASS 9.8

Please contact Sherex when using other grade fasteners.

\*Mechanical lock feature is available on all Full Hex parts. Please contact Sherex for details.

# CFW/CAW DIAMOND KNURLED 360° SWAGING SERIES

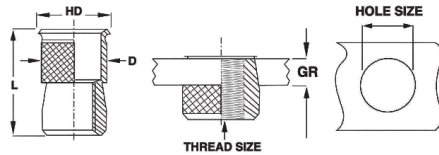

Material thickness .062"/1.57 min

## CFW/ CAW SERIES



### UNIFIED THREAD (UNIT - INCHES)

Part Number (Steel)	Thread Size	Cadmium Free & RoHS Compliant	HD ± .005	L ± .015	D Max.	Hole Size +.005/-0.00
CAW2-0632	6-32 UNC	N	.255	.370	.233	.234
CAW2-0832	8-32 UNC	N	.285	.370	.264	.266
CAW2-1024	10-24 UNC	N	.320	.370	.295	.297
CAW2-1032	10-32 UNF	N	.320	.370	.295	.297
CAW2-2520	1/4-20 UNC	N	.415	.515	.389	.391
CAW2-3118	5/16-18 UNC	N	.550	.615	.528	.531
CAW2-3716	3/8-16 UNC	N	.615	.740	.590	.594
CFW2-0632	6-32 UNC	Y	.255	.370	.233	.234
CFW2-0832	8-32 UNC	Y	.285	.370	.264	.266
CFW2-1024	10-24 UNC	Y	.320	.370	.295	.297
CFW2-1032	10-32 UNF	Y	.320	.370	.295	.297
CFW2-2520	1/4-20 UNC	Y	.415	.515	.389	.391
CFW2-3118	5/16-18 UNC	Y	.550	.615	.528	.531
CFW2-3716	3/8-16 UNC	Y	.615	.740	.590	.594

- The CFW/CAW series offers a knurled body for increased spin out resistance in soft materials such as fiberglass.
- Increased wall thickness gives increased shear strength.
- Cadmium Free finish allows the CFW Series to be used in any industry, including automotive.

### METRIC THREAD (UNIT - MILLIMETERS)

Part Number (Steel)	Thread Size	Cadmium Free & RoHS Compliant	HD ± .13	L ± .38	D Max.	Hole Size +.13/-0.00
CAW2-470	M4X0.7 ISO	N	7.24	9.40	6.71	6.75
CAW2-580	M5X0.8 ISO	N	8.13	9.40	7.50	7.54
CAW2-610	M6X1.0 ISO	N	10.54	13.08	9.88	9.92
CAW2-8125	M8X1.25 ISO	N	13.97	15.62	13.41	13.49
CAW2-1015	M10X1.5 ISO	N	15.62	18.80	14.99	15.00
CFW2-470	M4X0.7 ISO	Y	7.24	9.40	6.71	6.75
CFW2-580	M5X0.8 ISO	Y	8.13	9.40	7.50	7.54
CFW2-610	M6X1.0 ISO	Y	10.54	13.08	9.88	9.92
CFW2-8125	M8X1.25 ISO	Y	13.97	15.62	13.41	13.49
CFW2-1015	M10X1.5 ISO	Y	15.62	18.80	14.99	15.00

### PART NUMBERING SYSTEM

#### CFW/CAW Specifications

**Material:**  
Stainless Steel, 304 L  
Steel, 12L14  
Steel, 1215

**Finish:** CAW is Cadmium Plated per QQ-P-416 Type 1, Class 3 with clear protective coating  
CFW is Proprietary Tin Plated

**Part Number**  
Example: CAW2-2520

CAW	2	2520
Cadmium W series	Material	Thread Size
Featuring 360° Swaging	1-Stainless Steel	
	2-Steel	

*Special finish or material available upon request*

\*CFW and CAW rivet nut styles are dimensionally the same. CFW is Cadmium Free and RoHS Compliant.

Actual hole size can be affected by parent material and material thickness. Contact Sherex for details.  
CFW/CAW series available in different finishes. Other specials available upon request.  
Contact Sherex for test data.

#### INSTALLATION TOOLING

CFW/CAW Series can be installed with our Hand Tools, Pneumatic Tools, and Hydro-Pneumatic Tools.  
For additional tooling information see pages 41-45.

Sherex rivet nuts are compatible with the following hardware:  
**GRADE 2, GRADE 5, CLASS 8.8 and CLASS 9.8**  
Please contact Sherex when using other grade fasteners.

# CFT/CAT KNURLED 360° SWAGING SERIES

## CFT/ CAT SERIES



- The CFT/CAT series offers one rivet nut for materials of any thickness greater than .030 inches.

- Cadmium Free finish allows the CFT Series to be used in any industry, including automotive.

- Designed to be used in metal applications.



### UNIFIED THREAD (UNIT - INCHES)

Part Number (Steel)	Thread Size	Cadmium Free & RoHS Compliant	HD ± .005	L ± .015	D Max.	Recommended Hole Size +.005/- .00			
						MAT. THICK .030-.090	MAT. THICK .091-.124	MAT. THICK .125-.186	MAT. THICK .187-Over
CAT2-0440	4-40 UNC	N	.211	.370	.1875	.1875	.1935	.1935	.1960
CAT2-0632	6-32 UNC	N	.240	.370	.2185	.2188	.2210	.2280	.2280
CAT2-0832	8-32 UNC	N	.269	.370	.2495	.2500	.2570	.2656	.2656
CAT2-1024	10-24 UNC	N	.306	.370	.2805	.2812	.2900	.2900	.2969
CAT2-1032	10-32 UNF	N	.306	.370	.2805	.2812	.2900	.2900	.2969
CAT2-2520	1/4-20 UNC	N	.400	.515	.3745	.3750	.3750	.3860	.3906
CAT2-3118	5/16-18 UNC	N	.528	.615	.4995	.5000	.5000	.5156	.5156
CAT2-3716	3/8-16 UNC	N	.588	.745	.5615	.5625	.5625	.5781	.5781
CAT2-5013	1/2-13 UNC	N	.800	.935	.7485	.7500	.7656	.7810	.7970
CFT2-0440	4-40 UNC	Y	.211	.370	.1875	.1875	.1935	.1935	.1960
CFT2-0632	6-32 UNC	Y	.240	.370	.2185	.2188	.2210	.2280	.2280
CFT2-0832	8-32 UNC	Y	.269	.370	.2495	.2500	.2570	.2656	.2656
CFT2-1024	10-24 UNC	Y	.306	.370	.2805	.2812	.2900	.2900	.2969
CFT2-1032	10-32 UNF	Y	.306	.370	.2805	.2812	.2900	.2900	.2969
CFT2-2520	1/4-20 UNC	Y	.400	.515	.3745	.3750	.3750	.3860	.3906
CFT2-3118	5/16-18 UNC	Y	.528	.615	.4995	.5000	.5000	.5156	.5156
CFT2-3716	3/8-16 UNC	Y	.588	.745	.5615	.5625	.5625	.5781	.5781
CFT2-5013	1/2-13 UNC	Y	.800	.935	.7485	.7500	.7656	.7810	.7970

### METRIC THREAD (UNIT - MILLIMETERS)

Part Number (Steel)	Thread Size	Cadmium Free & RoHS Compliant	HD ± .13	L ± .38	D Max.	Recommended Hole Size +.13/- .00			
						MAT. THICK 0.76-2.29	MAT. THICK 2.31-3.15	MAT. THICK 3.17-4.72	MAT. THICK 4.72-Over
CAT2-350	M3X0.5 ISO	N	5.36	9.40	4.76	4.75	4.90	4.90	4.97
CAT2-470	M4X0.7 ISO	N	6.83	9.40	6.34	6.35	6.52	6.74	6.74
CAT2-580	M5X0.8 ISO	N	7.77	9.40	7.12	7.14	7.36	7.36	7.54
CAT2-610	M6X1.0 ISO	N	10.16	13.08	9.51	9.52	9.52	9.80	9.92
CAT2-8125	M8X1.25 ISO	N	13.41	15.62	12.69	12.70	12.70	13.09	13.09
CAT2-1015	M10X1.5 ISO	N	14.94	18.92	14.26	14.28	14.28	14.68	14.68
CAT2-12175	M12X1.75 ISO	N	20.32	23.75	19.01	19.05	19.44	19.83	20.24
CFT2-350	M3X0.5 ISO	Y	5.36	9.40	4.76	4.75	4.90	4.90	4.97
CFT2-470	M4X0.7 ISO	Y	6.83	9.40	6.34	6.35	6.52	6.74	6.74
CFT2-580	M5X0.8 ISO	Y	7.77	9.40	7.12	7.14	7.36	7.36	7.54
CFT2-610	M6X1.0 ISO	Y	10.16	13.08	9.51	9.52	9.52	9.80	9.92
CFT2-8125	M8X1.25 ISO	Y	13.41	15.62	12.69	12.70	12.70	13.09	13.09
CFT2-1015	M10X1.5 ISO	Y	14.94	18.92	14.26	14.28	14.28	14.68	14.68
CFT2-12175	M12X1.75 ISO	Y	20.32	23.75	19.01	19.05	19.44	19.83	20.24

### PART NUMBERING SYSTEM

#### CFT/CAT Specifications

##### Material:

Stainless Steel, 304 L  
Steel, 12L14  
Steel, 1215

**Finish:** CAT is Cadmium Plated per QQ-P-416 Type 1, Class 3 with clear protective coating

CFT is Proprietary Tin Plated

#### Part Number

Example: CAT2-2520

CAT	2	2520
Cadmium T series	Material	Thread Size
Featuring 360° Swaging	1-Stainless Steel	
	2-Steel	

*Special finish or material available upon request*

**\*CFT and CAT rivet nut styles are dimensionally the same. CFT is Cadmium Free and RoHS Compliant.**

Actual hole size can be affected by parent material and material thickness. Contact Sherex for details.  
CFT/CAT series available in different finishes. Other specials available upon request.  
Contact Sherex for test data.

#### INSTALLATION TOOLING

CFT/CAT Series can be installed with our Hand Tools, Pneumatic Tools, and Hydro-Pneumatic Tools. For additional tooling information see pages 41-45.  
Sherex rivet nuts are compatible with the following hardware: **GRADE 2, GRADE 5, CLASS 8.8 and CLASS 9.8** Please contact Sherex when using other grade fasteners.

**CFT Stainless Steel (CFT1) products are now produced in our Sherex Akron facility, and are available with reduced lead times!**



# CPB PREBULBED SLOTTED BODY SERIES

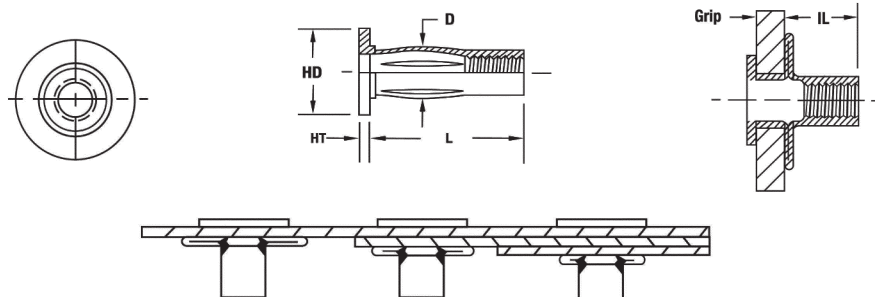

Installs into single, variable, or multiple thickness materials.

## CPB SERIES



### UNIFIED THREAD (UNIT - INCHES)

Part Number (Steel)	Thread Size	Grip Range		HD		L ±.015	HT ±.005	D Max.	IL Ref.	Hole Size +.006/-000
		Min.	Max.	Min.	Max.					
CPB2-1024-175	10-24 UNC	.020	.175	.490	.510	.828	.038	.329	.410	.336
CPB2-1024-320	10-24 UNC	.175	.320	.490	.510	.921	.038	.329	.410	.336
CPB2-1032-175	10-32 UNF	.020	.175	.490	.510	.828	.038	.329	.410	.336
CPB2-1032-320	10-32 UNF	.175	.320	.490	.510	.921	.038	.329	.410	.336
CPB2-2520-280	1/4-20 UNC	.020	.280	.610	.645	1.000	.059	.382	.505	.390
CPB2-2520-500	1/4-20 UNC	.280	.500	.610	.645	1.234	.059	.382	.505	.390
CPB2-3118-280	5/16-18 UNC	.020	.280	.740	.770	1.141	.062	.495	.570	.500
CPB2-3118-500	5/16-18 UNC	.280	.500	.740	.770	1.375	.062	.495	.570	.500

- The CPB series offers a large grip range for installation into single, variable or multiple thickness materials.
- Large backside footprint provides increased pull out resistance.
- Designed to be installed in thin plastics without distorting the base material.

### METRIC THREAD (UNIT - MILLIMETERS)

Part Number (Steel)	Thread Size	Grip Range		HD		L ±.0.38	HT ±.0.13	D Max.	IL Ref.	Hole Size +.15/-000
		Min.	Max.	Min.	Max.					
CPB2-580-4.45	M5x0.8 ISO	0.50	4.45	12.45	12.95	21.03	0.96	8.35	10.00	8.55
CPB2-580-8.1	M5x0.8 ISO	4.45	8.10	12.45	12.95	23.80	0.96	8.35	10.00	8.55
CPB2-610-7.1	M6x1.0 ISO	0.50	7.10	15.50	16.38	25.40	1.50	9.70	12.80	10.00
CPB2-610-12.7	M6x1.0 ISO	7.10	12.70	15.50	16.38	31.32	1.50	9.70	12.80	10.00
CPB2-8125-7.1	M8x1.25 ISO	0.50	7.10	18.80	19.65	28.95	1.57	12.57	14.48	12.70
CPB2-8125-12.7	M8x1.25 ISO	7.10	12.70	18.80	19.65	34.90	1.57	12.57	14.48	12.70

### PART NUMBERING SYSTEM

#### CPB Specifications

##### Material:

Steel 1008/1010  
Aluminum 5056

##### RoHS Compliant Finishes:

Zinc Plated-Yellow Trivalent Chromate per Sherex SFS-01-001, SC2  
Zinc Plated-Clear Trivalent Chromate per Sherex SFS-01-001

#### Part Number

Example: CPB2-2520-280

CPB	2	2520	280	( )
Product Style	2-Steel	Thread Size	Grip Range	Empty-Open End
Slotted Body	3-Aluminum			T-Clear Trivalent
Pre-bulbed				W-Wedge Head
				TR-Trim Head

Special finish or material available upon request

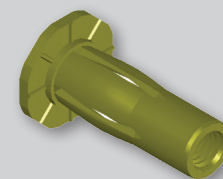

WEDGE HEAD

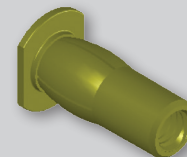

TRIM HEAD

Grip range can be affected by parent material and hole size. Sherex recommends trials installations to determine the proper grip range for the application. Contact Sherex for details. Contact Sherex for test data.

#### INSTALLATION TOOLING

CPB Series can be installed with our Hand Tools, Pneumatic Tools, and Hydro-Pneumatic Tools. For additional tooling information see pages 41-45.

Sherex rivet nuts are compatible with the following hardware:

**GRADE 2, GRADE 5, CLASS 8.8 and CLASS 9.8**

Please contact Sherex when using other grade fasteners.

# CPN STRAIGHT SHANK SLOTTED BODY SERIES

## CPN SERIES

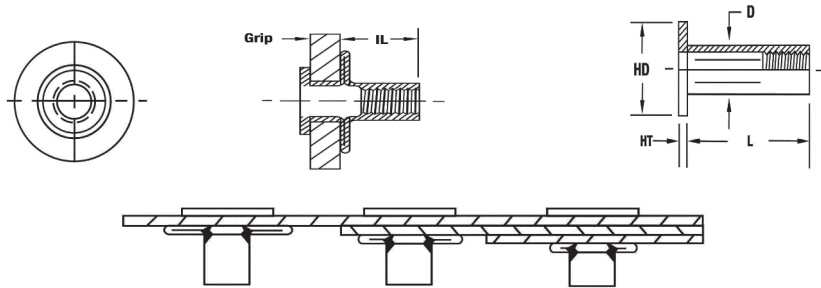

Installs into single, variable, or multiple thickness materials.



- The CPN series offers a large grip range for installation into single, variable or multiple thickness materials.
- Large backside footprint provides increased pull out resistance.
- Designed to be installed in thin plastics without distorting the base material.
- Must be installed with spin-pull installation tooling.

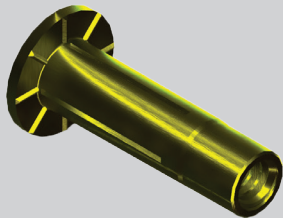

### WEDGE HEAD

## UNIFIED THREAD (UNIT - INCHES)

Part Number (Steel)	Thread Size	Grip Range		HD		L	HT	D	IL	Hole Size
		Min.	Max.	Min.	Max.	± .015	± .005	Max.	Ref.	+ .006/- .000
CPN2-1024-175	10-24 UNC	.020	.175	.490	.510	.781	.038	.272	.425	.273
CPN2-1024-320	10-24 UNC	.175	.320	.490	.510	.921	.038	.272	.425	.273
CPN2-1032-175	10-32 UNF	.020	.175	.490	.510	.781	.038	.272	.425	.273
CPN2-1032-320	10-32 UNF	.175	.320	.490	.510	.921	.038	.272	.425	.273
CPN2-2520-280	1/4-20 UNC	.020	.280	.610	.645	1.000	.059	.346	.505	.347
CPN2-2520-500	1/4-20 UNC	.280	.500	.610	.645	1.234	.059	.346	.505	.347
CPN2-3118-280	5/16-18 UNC	.020	.280	.740	.770	1.141	.062	.437	.570	.438
CPN2-3118-500	5/16-18 UNC	.280	.500	.740	.770	1.375	.062	.437	.570	.438

## METRIC THREAD (UNIT - MILLIMETERS)

Part Number (Steel)	Thread Size	Grip Range		HD		L	HT	D	IL	Hole Size
		Min.	Max.	Min.	Max.	± 0.38	± .13	Max.	Ref.	+ .15/- 0.00
CPN2-580-4.45	M5x0.8 ISO	0.50	4.45	12.45	12.95	21.03	0.96	7.47	9.90	7.48
CPN2-580-8.1	M5x0.8 ISO	4.45	8.10	12.45	12.95	23.80	0.96	7.47	9.90	7.48
CPN2-610-7.1	M6x1.0 ISO	0.50	7.10	15.50	16.38	25.40	1.50	8.79	12.80	8.80
CPN2-610-12.7	M6x1.0 ISO	7.10	12.70	15.50	16.38	31.32	1.50	8.79	12.80	8.80
CPN2-8125-7.1	M8x1.25 ISO	0.50	7.10	18.80	19.65	28.95	1.57	11.10	14.48	11.11
CPN2-8125-12.7	M8x1.25 ISO	7.10	12.70	18.80	19.65	34.90	1.57	11.10	14.48	11.11

## PART NUMBERING SYSTEM

### CPN Specifications

#### Material:

Steel 1008/1010

Aluminum 5056

#### RoHS Compliant Finishes:

Zinc Plated-Yellow Trivalent Chromate  
per Sherex SFS-01-001, SC2

Zinc Plated-Clear Trivalent Chromate  
per Sherex SFS-01-001

### Part Number

Example: CPN2-2520-280

CPN

Product Style

Slotted Body

Straight Shank

2

2-Steel

3-Aluminum

2520

Thread Size

280

Grip Range

( )

Empty-Open End

T-Clear Trivalent

W-Wedge Head

Special finish or material available upon request

Grip range can be affected by parent material and hole size.  
Sherex recommends trials installations to determine the proper grip range for the application.  
Contact Sherex for details.  
Contact Sherex for test data.

CPN Series must be installed with spin pull tooling.  
For more information see pages 41-45.

Sherex rivet nuts are compatible with the following hardware:  
**GRADE 2, GRADE 5, CLASS 8.8 and CLASS 9.8**  
Please contact Sherex when using other grade fasteners.

# CFH & CFHD FULL HEX BODY SERIES

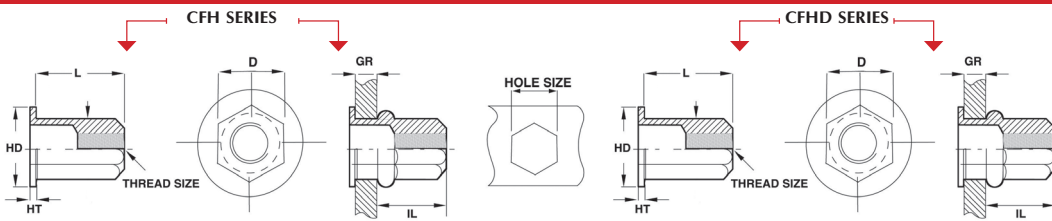

## CFH/ CFHD SERIES



- The CFH series offers a full hexagonal body for exceptional spin out resistance.

### CFH UNIFIED THREAD (UNIT - INCHES)

Part Number	Thread Size	Grip Range		HD		L	HT	D (A/F)	IL	Hole Size (A/F)
		Min.	Max.	Min.	Max.	± .015	Nom.	Max.	Ref.	+ .005/- .000
CFH2-1024-085	10-24 UNC	.010	.085	.329	.359	.344	.043	.223	.200	.224
CFH2-1024-135	10-24 UNC	.085	.135	.329	.359	.406	.043	.223	.210	.224
CFH2-1024-185	10-24 UNC	.135	.185	.329	.359	.453	.043	.223	.210	.224
CFH2-1032-085	10-32 UNF	.010	.085	.329	.359	.344	.043	.223	.200	.224
CFH2-1032-135	10-32 UNF	.085	.135	.329	.359	.406	.043	.223	.210	.224
CFH2-1032-185	10-32 UNF	.135	.185	.329	.359	.453	.043	.223	.210	.224
CFH2-2520-085	1/4-20 UNC	.020	.085	.422	.452	.406	.043	.296	.250	.297
CFH2-2520-145	1/4-20 UNC	.085	.145	.422	.452	.469	.043	.296	.250	.297
CFH2-2520-205	1/4-20 UNC	.145	.205	.422	.452	.531	.043	.296	.250	.297
CFH2-3118-105	5/16-18 UNC	.030	.105	.547	.577	.562	.048	.368	.375	.369
CFH2-3118-175	5/16-18 UNC	.105	.175	.547	.577	.640	.048	.368	.380	.369
CFH2-3118-245	5/16-18 UNC	.175	.245	.547	.577	.703	.048	.368	.375	.369
CFH2-3716-115	3/8-16 UNC	.030	.115	.641	.671	.625	.058	.437	.400	.438
CFH2-3716-205	3/8-16 UNC	.115	.205	.641	.671	.718	.058	.437	.405	.438
CFH2-3716-295	3/8-16 UNC	.205	.295	.641	.671	.812	.058	.437	.410	.438

### CFH METRIC THREAD (UNIT - MILLIMETERS)

Part Number	Thread Size	Grip Range		HD		L	HT	D (A/F)	IL	Hole Size (A/F)
		Min.	Max.	Min.	Max.	± .38	Nom.	Max.	Ref.	+ .13/- .000
CFH2-580-2.1	M5x0.8 ISO	0.50	2.15	9.14	9.90	10.30	1.09	6.35	6.72	6.35
CFH2-580-3.5	M5x0.8 ISO	2.15	3.55	9.14	9.90	11.90	1.09	6.35	6.72	6.35
CFH2-580-5.0	M5x0.8 ISO	3.55	5.05	9.14	9.90	13.48	1.09	6.35	6.72	6.35
CFH2-610-2.1	M6x1.0 ISO	0.50	2.15	10.71	11.47	10.30	1.09	7.51	6.22	7.51
CFH2-610-3.6	M6x1.0 ISO	2.15	3.65	10.71	11.47	11.90	1.09	7.51	6.22	7.51
CFH2-610-5.2	M6x1.0 ISO	3.65	5.20	10.71	11.47	13.48	1.09	7.51	6.22	7.51
CFH2-8125-2.5	M8x1.25 ISO	0.50	2.55	14.69	15.45	15.86	1.57	10.08	10.35	10.08
CFH2-8125-4.5	M8x1.25 ISO	2.50	4.55	14.69	15.45	17.84	1.57	10.08	10.35	10.08
CFH2-8125-6.6	M8x1.25 ISO	4.55	6.60	14.69	15.45	19.82	1.57	10.08	10.35	10.08
CFH2-1015-2.9	M10x1.50 ISO	0.75	2.95	17.10	17.86	15.88	1.57	11.89	13.08	11.89
CFH2-1015-5.2	M10x1.50 ISO	2.95	5.20	17.10	17.86	18.24	1.57	11.89	13.08	11.89
CFH2-1015-7.5	M10x1.50 ISO	5.20	7.50	17.10	17.86	20.62	1.57	11.89	13.08	11.89

### CFHD UNIFIED THREAD (UNIT - INCHES)

Part Number	Thread Size	Grip Range		HD		L	HT	D (A/F)	IL	Hole Size (A/F)
		Min.	Max.	Min.	Max.	± .015	Nom.	Max.	Ref.	+ .010/- .000
CFHD2-2520-080	1/4-20 UNC	.020	.080	.454	.484	.500	.058	.312	.340	.312
CFHD2-2520-150	1/4-20 UNC	.080	.150	.454	.484	.578	.058	.312	.345	.312
CFHD2-3118-100	5/16-18 UNC	.020	.100	.579	.609	.625	.062	.397	.405	.397
CFHD2-3118-180	5/16-18 UNC	.100	.180	.579	.609	.703	.062	.397	.405	.397
CFHD2-3716-125	3/8-16 UNC	.020	.125	.673	.703	.703	.088	.468	.450	.468
CFHD2-3716-230	3/8-16 UNC	.125	.230	.673	.703	.812	.088	.468	.450	.468



- The CFHD series offers the same benefits as the CFH series but with higher strength.

### PART NUMBERING SYSTEM

#### CFH/CFHD Specifications

#### Material:

Steel 1008/1010  
Stainless Steel 302  
Aluminum 5056

#### RoHS Compliant Finishes:

Zinc Plated-Yellow Trivalent Chromate per Sherex SFS-01-001, SC2  
Zinc Plated-Clear Trivalent Chromate per Sherex SFS-01-001

#### Part Number

Example: CFH2-2520-085

CFH	2	2520	085	( )	T
Full Hex	Material	Thread Size	Grip Range	Empty-Open End	Clear Trivalent
Heavy Duty	1-Stainless Steel			B-Closed End	
Large Flange	2-Steel				
CFHD - High Strength	3-Aluminum				

*Special finish or material available upon request*

Sherex rivet nuts are compatible with the following hardware:  
**GRADE 2, GRADE 5, CLASS 8.8 and CLASS 9.8**  
Please contact Sherex when using other grade fasteners.

# METRIC BODY STYLE RIVET NUTS

## METRIC BODY STYLE RIVET NUT



- Metric body styles are designed to be placed into metric drilled or punched holes.
- Many of the metric body styles are available with inch/imperial thread.
- Products are manufactured in our ISO/TS 16949, AS9100, and ISO 9001 certified production facility or in the EN 9100 certified production facility of our partner, DeJond®, in Belgium.
- Special designs are available to meet customer specific requirements. Contact Sherex with your application information.



### CATALOG ATTRIBUTES - METRIC BODY STYLE

<b>Grip Range(E)</b>	Material Thickness	<b>d</b>	Diameter
<b>L</b>	Length	<b>d(A/F)</b>	Diameter Across Flats
<b>D</b>	Head Diameter	<b>b</b>	Hole Size
<b>K</b>	Head Thickness		

# UPO/HUPO LARGE FLANGE METRIC SERIES

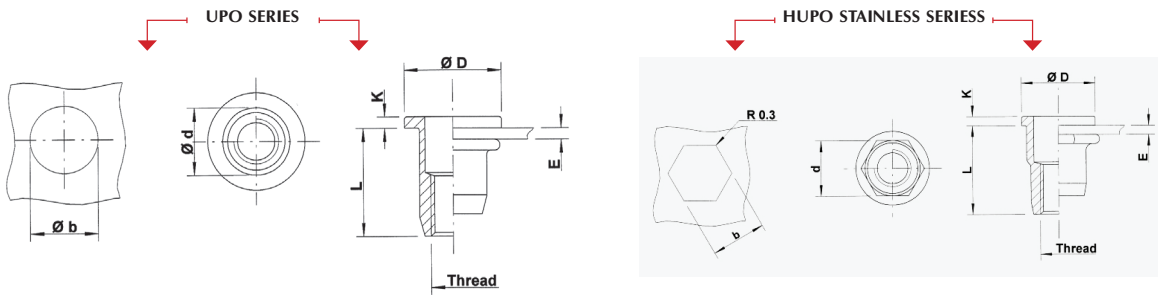

**UPO/  
HUPO  
SERIES**



## UPO SERIES

Part Number Steel	Thread Size	Grip Range (E)		L ± 0.35	D ± 0.35	K ± 0.15	d -0.02/-0.15	Hole Size (b+0.1)
		Min.	Max.					
TU-SM3UPO20ZT	M3X0.5 ISO	0.5	2.0	9.8	8.0	0.8	5.0	5.1
TU-SM3UPO30ZT	M3X0.5 ISO	2.0	3.0	10.8				
TU-SM4UPO30ZT	M4X0.7 ISO	0.5	3.0	10.8	10.0	0.8	6.0	6.0
TU-SM4UPO45ZT	M4X0.7 ISO	3.0	4.5	12.3				
TU-SM5UPO30ZT	M5X0.8 ISO	0.5	3.0	12.0	11.0	1.0	7.0	7.0
TU-SM5UPO55ZT	M5X0.8 ISO	3.0	5.5	15.0				
TU-SM6UPO30ZT	M6X1.0 ISO	0.5	3.0	14.5	13.0	1.5	9.0	9.0
TU-SM6UPO55ZT	M6X1.0 ISO	3.0	5.5	16.5				
TU-SM6UPO80ZT	M6X1.0 ISO	5.5	8.0	19.0				
TU-SM8UPO30ZT	M8X1.25 ISO	0.5	3.0	16.0	16.0	1.5	11.0	11.0
TU-SM8UPO55ZT	M8X1.25 ISO	3.0	5.5	18.5				
TU-SM8UPO80ZT	M8X1.25 ISO	5.5	8.0	21.5				
TU-SM10UPO35ZT	M10X1.5 ISO	0.8	3.5	19.8	18.5	2.3	12.4	12.5
TU-SM10UPO60ZT	M10X1.5 ISO	3.5	6.0	22.8				
TU-SM10SPO35ZT	M10X1.5 ISO	0.8	3.5	21.0	19.0	2.0	13.0	13.0
TU-SM10SPO60ZT	M10X1.5 ISO	3.5	6.0	24.0				
TU-SM12UPO40ZT	M12X1.75 ISO	1.0	4.0	25.0	23.0	2.0	16.0	16.0
TU-SM12UPO70ZT	M12X1.75 ISO	4.0	7.0	28.0				

## HUPO STAINLESS SERIES

Part Number Steel	Thread Size	Grip Range (E)		L ± 0.35	D +0.3/-0.15	K +0.3/-0.05	d (AP) -0.02/-0.15
		Min.	Max.				
TU-SS4HUPO20	M4 X0.7 ISO	0.5	2.0	11.0	9.0	1.0	6.0
TU-SS5HUPO30	M5 X0.8 ISO	0.5	3.0	11.5	10.0	1.0	7.0
TU-SS6HUPO30	M6 X1.0 ISO	0.5	3.0	14.5	12.0	1.5	9.0
TU-SS6HUPO50		3.0	5.0	16.5			
TU-SS8HUPO30	M8 X1.25 ISO	0.5	3.0	16.0	15.0	1.5	11.0
TU-SS8HUPO55	M8 X1.25 ISO	3.0	5.5	18.5			
TU-SS10HUPO35	M10X1.5 ISO	0.8	3.5	21.5	17.0	1.5	13.0

## PART NUMBERING SYSTEM

UPO Specifications	Part Number
<b>Material</b> Steel QST 34-3 Stainless Steel 304 Cu Stainless Steel 316 Cu Aluminum ALMG 2.5	Example: TU-SM5UPO30ZT
<b>RoHs Compliant Finish:</b> Zintop (Clear), 96 w / 480 r	

TU S M5 U P O 30 Z T  
 Material Thread Size Product Type Grip Range Zintop (Clear)  
 S-Steel Large Flange, Flat Head X-Closed End  
 A-Aluminum Metric Body  
 SS-304 Stainless Steel  
**\*316-316 Stainless Steel**

*Special finish or material available upon request*

**\*316 Stainless Steel has extra corrosion resistance and can be used in the medical, chemical and food industries.**

Grip Range can be affected by parent material and hole size. Sherex recommends trial installations to determine the proper grip range for the application. Closed End sizes available: M4, M5, M6, and M8. Also available with imperial threads - minimum order quantity is 25,000 pieces if not in stock. Contact Sherex for test data.

### INSTALLATION TOOLING

UPO Series can be installed with our Hand Tools, and Hydro-Pneumatic Tools. For additional tooling information see pages 41-45.

All Parts have been manufactured by: **DEJOND**  
MFTAL MATTEK

TUBTARA® - A DEJOND PRODUCT  
 Sherex rivet nuts are compatible with the following hardware:  
**GRADE 2, GRADE 5, CLASS 8.8 and CLASS 9.8**  
 Please contact Sherex when using other grade fasteners.

Sherex Fastening Solutions • Phone: 866-474-3739 • Fax: 716-875-0358 • www.sherex.com • E-mail: info@sherex.com



- The UPO series offers a large flange for increased strength and better containment of round or oversized holes.

- The metric body dimensions allow for use in metric holes.



- The HUPO series has a large flange that provides increased strength.

- Hexagonal shank body for improved spin out.

- The metric body dimensions allow for use in metric holes.



# UFO COUNTERSUNK HEAD & UKO SMALL FLANGE METRIC SERIES

## UFO/ UKO SERIES



- The UFO series offers a countersunk head for flush installation into the parent materials.

- The metric body dimensions allow for use in metric holes.



- The UKO series offers a small flange head for near flush installation.

- The metric body dimensions allow for use in metric size holes.

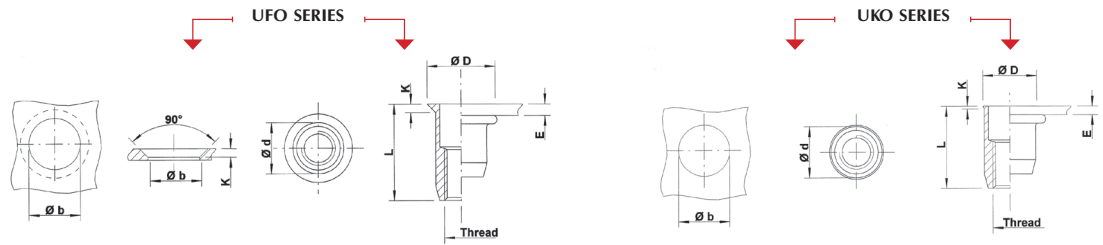

### METRIC THREAD (UNIT - MILLIMETERS)

Part Number Steel	Thread Size	Grip Range (E)		OL ± 0.35	D +0.00/-0.5	K +0.3/-0.05	d -0.02/-0.15	Hole Size (b+0.1)
		Min.	Max.					
TU-SM3UFO35ZT	M3X0.5 ISO	1.7	3.5	11.25	8.0	1.5	5.0	5.1
TU-SM4UFO35ZT	M4X0.7 ISO	1.7	3.5	11.5				
TU-SM4UFO50ZT	M4X0.7 ISO	3.5	5.0	13.0	9.0	1.5	6.0	6.0
TU-SM5UFO40ZT	M5X0.8 ISO	1.7	4.0	13.0				
TU-SM5UFO65ZT	M5X0.8 ISO	4.0	6.5	16.0	10.0	1.5	7.0	7.0
TU-SM6UFO45ZT	M6X1.0 ISO	1.7	4.5	17.0				
TU-SM6UFO65ZT	M6X1.0 ISO	4.5	6.5	19.0	12.0	1.5	9.0	9.0
TU-SM8UFO45ZT	M8X1.25 ISO	1.7	4.5	19.0				
TU-SM8UFO65ZT	M8X1.25 ISO	4.5	6.5	21.0	14.0	1.5	11.0	11.0
TU-SM10UFO45ZT	M10X1.5 ISO	1.7	4.5	21.0				
TU-SM10UFO65ZT	M10X1.5 ISO	4.5	6.5	23.0	15.4	1.5	12.4	12.5
TU-SM12UFO45ZT	M12X1.75 ISO	2.0	4.5	26.0				
TU-SM12UFO75ZT	M12X1.75 ISO	4.5	7.5	29.0	19.0	1.8	16.0	16.0

### METRIC THREAD (UNIT - MILLIMETERS)

Part Number Steel	Thread Size	Grip Range (E)		OL ± 0.35	D +0.3/-0.15	K +0.3/-0.05	d -0.02/-0.15	Hole Size (b+0.1)
		Min.	Max.					
TU-SM4UKO30ZT	M4X0.7 ISO	0.5	3.0	10.75	6.5	0.5	6.0	6.0
TU-SM5UKO30ZT	M5X0.8 ISO	0.5	3.0	12.0				
TU-SM5UKO55ZT	M5X0.8 ISO	3.0	5.5	15.0	7.5	0.5	7.0	7.0
TU-SM6UKO30ZT	M6X1.0 ISO	0.5	3.0	14.5				
TU-SM6UKO55ZT	M6X1.0 ISO	3.0	5.5	16.5	9.5	0.5	9.0	9.0
TU-SM8UKO30ZT	M8X1.25 ISO	0.5	3.0	16.0				
TU-SM8UKO55ZT	M8X1.25 ISO	3.0	5.5	18.5	11.5	0.5	11.0	11.0
TU-SM10UKO35ZT	M10X1.5 ISO	0.8	3.5	19.5				

### PART NUMBERING SYSTEM

UFO Specifications	Part Number							
<b>Material:</b> Steel QST 34-3 Stainless Steel 304 Cu Aluminum ALMG 2.5	Example: TU-SM5UFO35ZT							
<b>RoHs Compliant Finish:</b> Zinktop (Clear), 96 w / 480 r	TU	S	M5	UF	O	35	ZT	
	Product Style:	Material	Thread Size	Product Type	O-Open End	Grip range	Zinktop (Clear)	
	Metric	S-Steel		Smooth Shank	X-Closed End			
		A-Aluminum		Countersunk Head				
		SS-304 Stainless Steel		Metric Body				
<b>UFO Specifications</b>	<b>Part Number</b>							
<b>Material:</b> Steel QST 34-3 Stainless Steel 304 Cu Stainless Steel 316 Cu Aluminum ALMG 2.5	Example: TU-SM5UKO30ZT							
<b>RoHs Compliant Finish:</b> Zinktop (Clear), 96 w / 480 r	TU	S	M5	UK	O	30	ZT	
	Product Style:	Material	Thread Size	Product Type	O-Open End	Grip range	Zinktop (Clear)	
	Metric	S-Steel		Smooth Shank	X-Closed End			
		A-Aluminum		Small Flange, Round Body				
		SS-304 Stainless Steel		Metric Body				
		<b>*316-316 Stainless Steel</b>						

Special finish or material available upon request

**\*316 Stainless Steel has extra corrosion resistance and can be used in the medical, chemical and food industries.**

Grip Range can be affected by parent material and hole size.

Sherex recommends trial installations to determine the proper grip range for the application.

RoHs Compliant Trivalent Plating available upon request.

Closed End sizes available: M4, M5, M6, M8. Also available with imperial threads - minimum order quantity is 25,000 pieces if not in stock.

Contact Sherex for test data.

#### INSTALLATION TOOLING

HUPO/HUKO Series can be installed with our Hand Tools and Hydro-Pneumatic Tools.

For additional tooling information see pages 41-45.

All Parts have been manufactured by **DEJOND**

TUBTARA® - A DEJOND PRODUCT

Sherex rivet nuts are compatible with the following hardware:

**GRADE 2, GRADE 5, CLASS 8.8 and CLASS 9.8**

Please contact Sherex when using other grade fasteners.

# HUPO LARGE FLANGE AND HUKO SMALL FLANGE HEXAGONAL METRIC SERIES

## HUPO SERIES

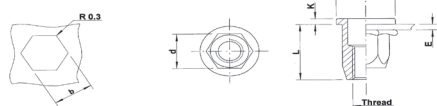

## HUKO SERIES

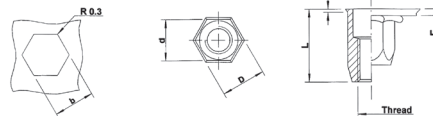

### HUPO METRIC THREAD (UNIT - MILLIMETERS)

Part Number Steel	Thread Size	Grip Range (E)		L ± 0.35	D ± 0.35	K ± 0.15	d (A/F) -0.02/-0.15	Hole Size (b+0.1)
		Min.	Max.					
TU-SM4HUPO20ZT	M4X0.7 ISO	0.5	2.0	10.0	9.0	1.0	6.0	6.0
TU-SM5HUPO30ZT	M5X0.8 ISO	0.5	3.0	13.0	10.0	1.0	7.0	7.0
TU-SM6HUPO30ZT	M6X1.0 ISO	0.5	3.0	14.5	13.0	1.5	9.0	9.0
TU-SM6HUPO55ZT	M6X1.0 ISO	3.0	5.5	16.5				
TU-SM8HUPO30ZT	M8X1.25 ISO	0.5	3.0	16.5	16.0	1.5	11.0	11.0
TU-SM8HUPO55ZT	M8X1.25 ISO	3.0	5.5	19.0				
TU-SM8HUPO80ZT	M8X1.25 ISO	5.5	8.0	22.0	19.0	2.0	13.0	13.0
TU-SM10HSP035ZT	M10X1.5 ISO	0.8	3.5	21.0				
TU-SM10HSP060ZT	M10X1.5 ISO	3.5	6.0	23.5	23.0	2.0	16.0	16.0
*TU-SM12HUPO40ZT	M12X1.75 ISO	1.0	4.0	25.0				

### HUKO METRIC THREAD (UNIT - MILLIMETERS)

Part Number Steel	Thread Size	Grip Range (E)		L ± 0.35	D +0.3/-0.15	K +0.3/-0.05	d (A/F) -0.02/-0.15	Hole Size (b+0.1)
		Min.	Max.					
TU-SM4HUKO20ZT	M4X0.7 ISO	0.5	2.0	11.0	6.6	0.6	6.0	6.0
TU-SM5HUKO30ZT	M5X0.8 ISO	0.5	3.0	14.0	7.7	0.6	7.0	7.0
TU-SM5HUKO55ZT	M5X0.8 ISO	3.0	5.5	16.5				
TU-SM6HUKO30ZT	M6X1.0 ISO	0.5	3.0	16.0	9.8	0.7	9.0	9.0
TU-SM6HUKO55ZT	M6X1.0 ISO	3.0	5.5	18.5				
TU-SM8HUKO30ZT	M8X1.25 ISO	0.5	3.0	18.0	11.8	0.7	11.0	11.0
TU-SM8HUKO55ZT	M8X1.25 ISO	3.0	5.5	20.5				
TU-SM10HUKO35ZT	M10X1.5 ISO	0.8	3.5	23.0	13.8	0.7	13.0	13.0

### PART NUMBERING SYSTEM

#### HUPO/HUKO Specifications

#### Part Number

Example: TU-SM5HUPO30ZT

#### Material:

Steel QST 34-3

Stainless Steel 304 Cu

Stainless Steel 316 Cu

TU

Product Style

Metric

S

Material

S-Steel

SS-304 Stainless Steel

M5

Thread Size

HUP

Product Type

Large Flange

Flat Head

Hexagonal Shank

Metric Body

\*Semi-Hexagonal Shank

O

O-Open End

X

Closed End

#### RoHs Compliant Finish:

Zinktop (Clear), 96 w / 480 r

#### Part Number

Example: TU-SM5HUKO30ZT

TU

Product Style

Metric

S

Material

S-Steel

SS-304 Stainless Steel

M5

Thread Size

HUK

Product Type

Small Flange

Round Body

Hexagonal Shank

Metric Body

O

O-Open End

X

Closed End

Special finish or material available upon request  
All Stainless Steel parts are semi-hexagonal shank.



- The HUPO series has a large flange that provides increased strength.

- Hexagonal shank body for improved spin out.

- The metric body dimensions allow for use in metric holes.



- The HUKO series has a smaller flange head that gives a near flush installation into the parent material.

- Hexagonal shank body for improved spin out.

- The metric body dimensions allow for use in metric holes.

Grip Range can be affected by parent material and hole size.

Sherex recommends trial installations to determine the proper grip range for the application.

RoHS Compliant Trivalent Plating available upon request.

Closed End sizes available: M4, M5, M6, M8. Also available with imperial threads - minimum order quantity is 25,000 pieces if not in stock.

Contact Sherex for test data.

#### INSTALLATION TOOLING

HUPO/HUKO Series can be installed with our Hand Tools and Hydro-Pneumatic Tools.

For additional tooling information see pages 41-45.

All Parts have been manufactured by: **DEJOND**

METAL MATTERS

TUBTARA® - A DEJOND PRODUCT

Sherex rivet nuts are compatible with the following hardware:

**GRADE 2, GRADE 5, CLASS 8.8 and CLASS 9.8**

Please contact Sherex when using other grade fasteners.

# UPO RS LARGE FLANGE AND UFO RS COUNTERSUNK HEAD KNURLED METRIC SERIES

## UPO RS/ UFO RS SERIES

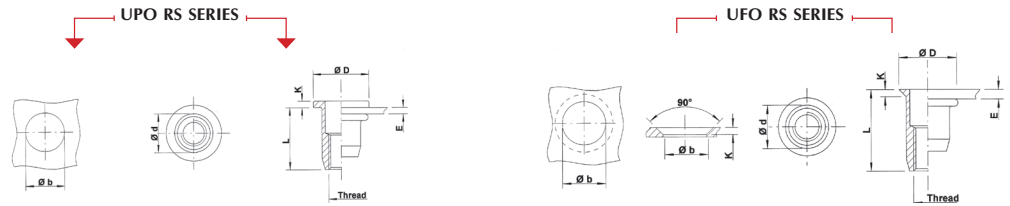

- The UPO RS series has a large flange that provides increased strength and better containment of round or oversized holes.

- Unique knurling increases spin out resistance in soft materials.



- The UFO RS has a countersunk head style for flush installations.

- Unique knurling increases spin out resistance.

### UPO RS METRIC THREAD (UNIT - MILLIMETERS)

Part Number Steel	Thread Size	Grip Range (E)		L ± 0.35	D ± 0.35	K ± 0.15	d -0.02/-0.15	Hole Size (b+0.1)
		Min.	Max.					
TU-SM4UPO30RZT	M4X0.7 ISO	0.5	3.0	10.75	10.0	0.75	6.3	6.4
TU-SM4UPO45RZT	M4X0.7 ISO	3.0	4.5	12.25				
TU-SM5UPO30RZT	M5X0.8 ISO	0.5	3.0	12.0	11.0	1.0	7.3	7.4
TU-SM5UPO55RZT	M5X0.8 ISO	3.0	5.5	15.0				
TU-SM6UPO30RZT	M6X1.0 ISO	0.5	3.0	14.5	13.0	1.5	9.3	9.4
TU-SM6UPO55RZT	M6X1.0 ISO	3.0	5.5	16.5				
TU-SM8UPO30RZT	M8X1.25 ISO	0.5	3.0	16.0	16.0	1.5	11.4	11.5
TU-SM8UPO55RZT	M8X1.25 ISO	3.0	5.5	18.5				
TU-SM10UPO35RZT	M10X1.5 ISO	0.8	3.5	19.75	18.5	2.25	12.9	13.0
TU-SM10UPO60RZT	M10X1.5 ISO	3.5	6.0	22.75				

### UFO RS METRIC THREAD (UNIT - MILLIMETERS)

Part Number Steel	Thread Size	Grip Range (E)		L ± 0.35	D +0.00/-0.5	K +0.3/-0.05	d -0.02/-0.15	Hole Size (b+0.1)
		Min.	Max.					
TU-SM4UFO35RZT	M4X0.7 ISO	1.7	3.5	11.5	9.0	1.5	6.3	6.4
TU-SM4UFO50RZT	M4X0.7 ISO	3.5	5.0	13.0				
TU-SM5UFO40RZT	M5X0.8 ISO	1.7	4.0	13.0	10.0	1.5	7.3	7.4
TU-SM5UFO65RZT	M5X0.8 ISO	4.0	6.5	16.0				
TU-SM6UFO45RZT	M6X1.0 ISO	1.7	4.5	17.0	12.0	1.5	9.3	9.4
TU-SM6UFO65RZT	M6X1.0 ISO	4.5	6.5	19.0				
TU-SM8UFO45RZT	M8X1.25 ISO	1.7	4.5	19.0	14.0	1.5	11.4	11.5
TU-SM8UFO65RZT	M8X1.25 ISO	4.5	6.5	21.0				
TU-SM10UFO45RZT	M10X1.5 ISO	1.7	4.5	21.0	15.4	1.5	12.9	13.0
TU-SM10UFO65RZT	M10X1.5 ISO	4.5	6.5	23.0				

### PART NUMBERING SYSTEM

#### UPO RS/UFO RS Specifications

**Material:**  
Steel QST 34-3

**RoHs Compliant Finish:**  
Zinktop (Clear), 96 w / 480 r

#### Part Number

Example: TU-SM5UPO30RZT

TU	S	M5	UP	O	30	R	ZT
Product Style:	Material	Thread Size	Product Type	O-Open End	Grip	Ribbed	Zinktop (Clear)
Metric	S-Steel		Large Flange, Flat Head				
			Metic Body				

#### Part Number

Example: TU-SM5UFO40RZT

TU	S	M5	UF	O	30	R	ZT
Product Style:	Material	Thread Size	Product Type	O-Open End	Grip	Ribbed	Zinktop (Clear)
Metric	S-Steel		Smooth Shank				
			Countersunk Head				
			Metic Body				

*Special finish or material available upon request*

Grip Range can be affected by parent material and hole size.  
Sherex recommends trial installations to determine the proper grip range for the application.  
RoHS Compliant Trivalent Plating available upon request.  
Also available with imperial threads - minimum order quantity is 25,000 pieces if not in stock.  
Contact Sherex for test data.

#### INSTALLATION TOOLING

UPO RS/ UFO RS Series can be installed with our Hand Tools and Hydro-Pneumatic Tools.  
For additional tooling information see pages 41-45.

All Parts have been manufactured by: DEJOND METAL MATTERS

TUBTARA® - A DEJOND PRODUCT  
Sherex rivet nuts are compatible with the following hardware:  
**GRADE 2, GRADE 5, CLASS 8.8 and CLASS 9.8**  
Please contact Sherex when using other grade fasteners.



# UKO/HUKO IMPERIAL THREAD SERIES – STAINLESS STEEL

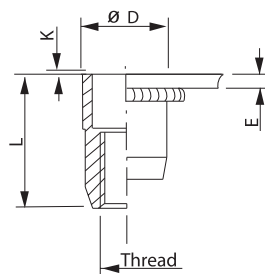
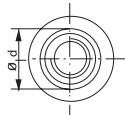
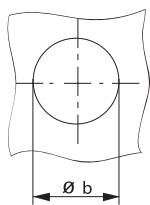

## UKO/ HUKO INCH SERIES



### UKO UNIFIED THREAD (UNIT - INCHES)

Part Number (304 Stainless Steel)	Thread Size	Grip Range (E)		L	D	K	Diameter-Inch (d)	Diameter-Metric (d)	Hole Size - Inch (b <sup>+0.04</sup> )	Hole Size - Metric (b <sup>+0.1</sup> )
		Min.	Max.							
TU-SS1032UKO30	10-32 UNF	.020	.118	.472	.295	.020	.276	7.0	.276	7.0
TU-SS2520UKO30	1/4-20 UNC	.020	.118	.571	.374	.020	.354	9.0	.354	9.0
TU-SS3118UKO30	5/16-18 UNC	.020	.118	.630	.453	.020	.433	11.0	.433	11.0

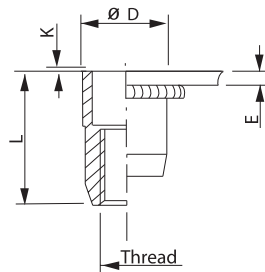
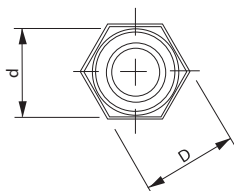
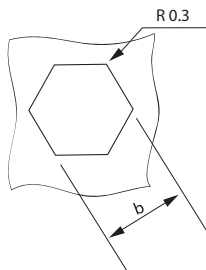

- The UKO inch series has a smaller flange head that gives a near flush installation.
- Round shank body.
- Dimensions in inches.

### HUKO UNIFIED THREAD (UNIT - INCHES)

Part Number (304 Stainless Steel)	Thread Size	Grip Range (E)		L	D	K	Diameter-Inch (d) (A/F)	Diameter-Metric (d) (A/F)	Hole Size - Inch (b <sup>+0.04</sup> ) (A/F)	Hole Size - Metric (b <sup>+0.1</sup> ) (A/F)
		Min.	Max.							
TU-SS1032HUKO30	10-32 UNF	.020	.118	.472	.295	.020	.276	7.0	.276	7.0
TU-SS2520HUKO30	1/4-20 UNC	.020	.118	.571	.374	.020	.354	9.0	.354	9.0
TU-SS3118HUKO30	5/16-18 UNC	.020	.118	.630	.453	.020	.433	11.0	.433	11.0



- The HUKO inch series has a smaller flange head that gives a near flush installation.
- Hexagonal shank body.
- Dimensions in inches.

### PART NUMBERING SYSTEM

#### UKO/HUKO Specifications

**Material:**  
Stainless Steel 304 Cu  
Stainless Steel 316 Cu

#### Part Number

Example: TU-SS1032HUKO30

TU	Product Style	SS	Material	1032	Thread Size	HUK	Product Type	O	Open End	30	Grip Range
	Metric	SS-304	Stainless Steel				Small Flange	X	Closed End		
		<b>*316-316 Stainless Steel</b>									

*Special finish or material available upon request*

**\*316 Stainless Steel has extra corrosion resistance and can be used in the medical, chemical and food industries.**

Grip Range can be affected by parent material and hole size.  
Sherex recommends trial installations to determine the proper grip range for the application.  
RoHS Compliant Trivalent Plating available upon request.  
Also available with imperial threads - minimum order quantity is 25,000 pieces if not in stock.  
Contact Sherex for test data.

#### INSTALLATION TOOLING

UKO/HUKO Inch Series can be installed with our Hand Tools and Hydro-Pneumatic Tools.  
For additional tooling information see pages 41-45.

All Parts have been manufactured by:  **DEJOND**  
METAL MATTERS

TUBTARA® - A DEJOND PRODUCT  
Sherex rivet nuts are compatible with the following hardware:  
**GRADE 2, GRADE 5, CLASS 8.8 and CLASS 9.8**  
Please contact Sherex when using other grade fasteners.

# CLM LARGE FLANGE AND CKM SMALL FLANGE

## CLM/ CKM SERIES



- The CLM series is the metric body version of the CAL series.

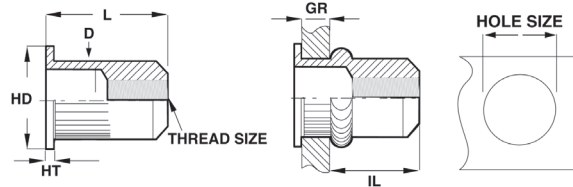

### CLM METRIC THREAD (UNIT - MILLIMETERS)

Part Number Metric - Steel	Thread Size	Grip Range (E)		L Nom.	HD		HT ±.13	D Max.	IL Ref.	Hole Size +0.10/- .000
		Min.	Max.		Min.	Max.				
CLM2-470-3.0	M4X0.7 ISO	0.25	3.00	11.5	8.62	9.38	0.75	5.95	7.10	6.00
CLM2-580-3.0	M5X0.8 ISO	0.25	3.00	13.0	9.62	10.38	1.00	6.95	7.90	7.00
CLM2-610-3.0	M6X1.0 ISO	0.50	3.00	16.0	12.62	13.38	1.50	8.95	9.40	9.00
CLM2-8125-3.0	M8X1.25 ISO	0.50	3.00	17.5	15.62	16.38	1.50	10.95	11.00	11.00
CLM2-1015-3.5	M10X1.5 ISO	0.50	3.50	22.0	18.12	18.88	2.25	12.95	14.50	13.00

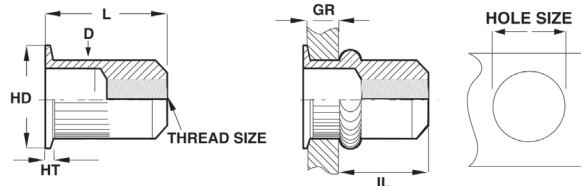

### CKM METRIC THREAD (UNIT - MILLIMETERS)

Part Number Metric - Steel	Thread Size	Grip Range (E)		L Nom.	HD		HT ±.13	D Max.	IL Ref.	Hole Size +0.10/- .000
		Min.	Max.		Min.	Max.				
CKM2-470-3.0	M4X0.7 ISO	0.25	3.00	11.3	6.70	7.20	0.46	5.95	7.10	6.00
CKM2-580-3.0	M5X0.8 ISO	0.25	3.00	12.7	7.70	8.20	0.46	6.95	7.90	7.00
CKM2-610-3.0	M6X1.0 ISO	0.50	3.00	15.3	9.70	10.20	0.50	8.95	9.40	9.00
CKM2-8125-3.0	M8X1.25 ISO	0.50	3.00	17.3	11.62	12.38	0.63	10.95	11.00	11.00
CKM2-1015-3.5	M10X1.5 ISO	0.50	3.50	20.4	13.62	14.38	0.80	12.95	14.50	13.00



- The CKM series is the metric body version of the CAK series.

### PART NUMBERING SYSTEM

#### CLM/CKM Specifications

##### Material:

Steel 1008/1010  
Aluminum 5056

##### RoHS Compliant Finishes:

Zinc Plated-Yellow Trivalent Chromate  
per Sherex SFS-01-001, SC2  
Zinc Plated-Clear Trivalent Chromate  
per Sherex SFS-01-001

#### Part Number

Example: CLM2-610-3.0

CLM	2	610	3.0	( )
Product Style	Material	Thread Size	Grip Range	Empty-Open End
Large Flange	2-Steel			B-Closed End
Knurled Body	3-Aluminum			T-Clear Trivalent
Metric Body				
CKM	2	610	3.0	( )
Product Style	Material	Thread Size	Grip Range	Empty-Open End
Small Flange	2-Steel			B-Closed End
Knurled Body	3-Aluminum			T-Clear Trivalent
Metric Body				

*Special finish or material available upon request*

Grip range can be affected by parent material and hole size. Sherex recommends trial installations to determine the proper grip range for the application.  
Contact Sherex for details.

CLM & CKM style rivet nut specials available upon request.  
Contact Sherex for test data.

#### INSTALLATION TOOLING

CLM/CKM Series can be installed with our Hand Tools, and Hydro-Pneumatic Tools.  
For additional tooling information see pages 41-45.

Sherex rivet nuts are compatible with the following hardware:  
**GRADE 2, GRADE 5, CLASS 8.8 and CLASS 9.8**  
Please contact Sherex when using other grade fasteners.



**PLATING: CR AND CRE SERIES**

**Corrosion Resistant - Long Life Plating Options**

**CR SERIES**

- Proprietary Zinc Nickel Plating.
- Certified to over 1,000 hrs of corrosion protection before red rust.
- Available on all rivet nuts in silver (standard), black or yellow.

**CRE SERIES**

- Proprietary Zinc Plating.
- More economical for lower corrosion resistance requirements.
- Certified to over 500 hrs of corrosion protection before red rust.
- Available in silver (standard) or black.

**RoHS**

- The CR & CRE Series are RoHS compliant.
- Our plating process contains neither hexavalent nor trivalent chromate.

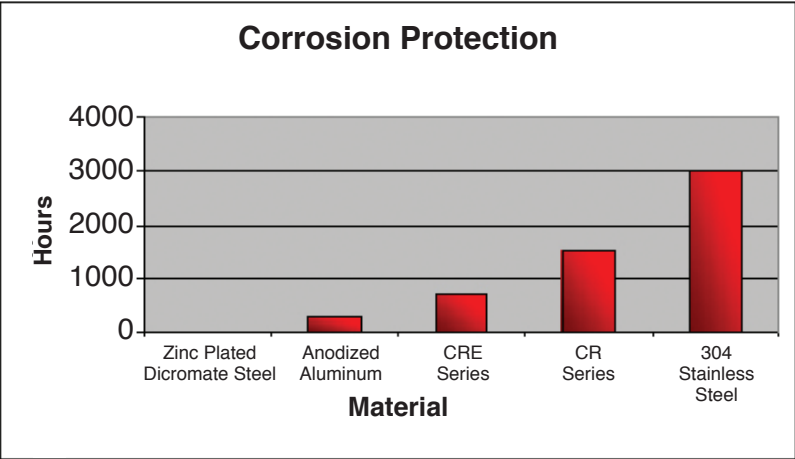

Additional information and Sherex white paper available at [www.sherex.com](http://www.sherex.com)

**Ordering & Inquires**

When inquiring about the **CR and CRE Series** finishes, simply replace the first 2 letters of the part number with **CR** or **CRE**.

Example: **CAL2-2520-165** becomes **CREL2-2520-165**

For non-standard finish, contact Sherex for ordering details.

Sherex CR Black = **CRB**, Sherex CR Yellow = **CRY**, Sherex CRE Black = **CREB**



## SHEREX LOCSERT®



Sherex Locsert® is a proprietary adhesive that is pre-applied under the head of the rivet nut. When installed, the adhesive bonds the rivet nut to the base material, greatly increasing the force required to spin the rivet nut. (This is commonly referred to as “spin out.”)

*adhesive activates during installation bonding rivet nut to base material*

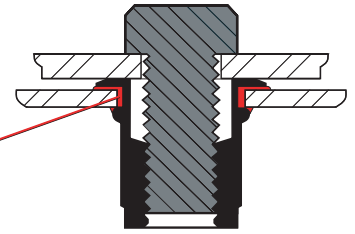

### PRODUCT FEATURES AND BENEFITS

- Base material must be a ferrous or non-ferrous metal.
- Base material should not be painted or powder coated (finish will reduce performance).
- Base material should be as clean as possible prior to rivet nut installation.
- Hole should be relatively free of burrs.
- Bonding begins immediately, but allow 2-3 hours for approximately 75% curing. Locsert® will be fully cured within 24 hours.
- Locsert® performance will improve 20-30% when post bake associated with e-coat, powdercoat or paint finish is performed *AFTER* Locsert® installation.

Base Material: 1018 steel, 70HRB, .063 thickness

Part Number	Spin Out (in - lb)	With LocSert®	Set Time
CAL2-2520-165	42.90	90.08	3 hours

For additional testing data, please contact Sherex

# SHEREX SEAL 2 SEALING SYSTEM

## SEAL 2 SEALING SYSTEM



Sherex Seal 2 has been designed for use in applications where it is necessary to seal fluid or air leakage from under the head. Seal 2 provides greater performance over conventional sealing materials such as PVC foam.

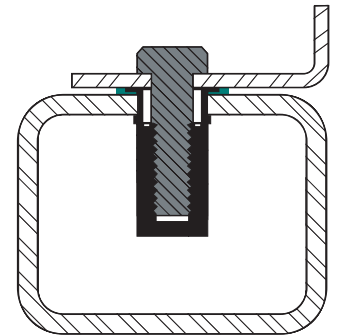

### BENEFITS

- Resistant to automotive fluids.
- Can withstand temperatures up to 150° C.
- Has been pressure tested to 160 psi of backside pressure with no leakage.
- Seal 2 processed rivet nuts can be installed into any finished materials.
- Seal 2 can pass through a paint bake or other baking process for up to 30 minutes with no reduction in sealing capabilities.
- Can be applied to a standard large flange rivet nut.

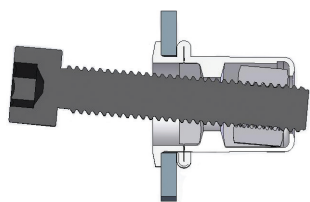

CROSS SECTION OF RIV-FLOAT® INSTALLED

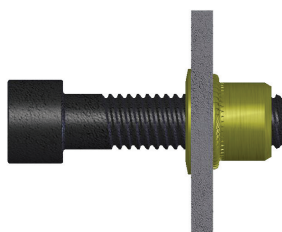

STANDARD RIVET NUT INSTALLED

## FEATURES AND BENEFITS

- Accounts for tolerance stack up in joint design and misalignment during service of the joint.
- Floating nut aligns to drive angle of screw virtually eliminating cross threading and spin out.
- Allows for installation in post painted or powder coat applications where riveted nut plates or cage nuts are typically used.
- RoHS compliant Zinc electroplate to 8µm with trivalent chromate - 96/240 hrs (WR/RR).
- Designed with higher thread strength than regular rivet nuts.
- Mechanically locked RIV-FLOAT® is available with prevailing torque feature to IFI spec 100/107.

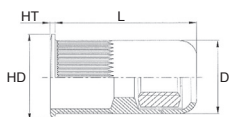

UNINSTALLED

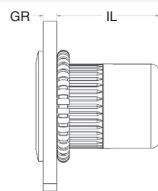

INSTALLED

## RFK INCH THREAD SMALL FLANGE SERIES (UNIT - INCHES)

Part Number Inch (Steel)	Thread Size	Radial Deflection	Grip Range		L ± .0215	HD ± .010	HT ± .002	D Max.	IL Ref.	Hole Size +.006/-0.000
			Min.	Max.						
RFK2-0632-130	6-32 UNC	.020	.027	.130	.7195	.455	.022	.390	.522	.391
RFK2-0832-130	8-32 UNC	.020	.027	.130	.7195	.455	.022	.390	.522	.391
RFK2-1032-150	10-32 UNF	.015	.027	.150	.7195	.455	.022	.390	.522	.391
RFK2-2520-150	1/4-20 UNC	.030	.027	.150	.8190	.595	.022	.530	.630	.531

## RFK METRIC THREAD SMALL FLANGE SERIES (UNIT - MILLIMETERS)

Part Number Metric (Steel)	Thread Size	Radial Deflection	Grip Range		L ± .55	HD ± .25	HT ± .05	D Max.	IL Ref.	Hole Size +.15/-0.000
			Min.	Max.						
RFK2-470-3.3	M4x0.7 ISO	.51	0.70	3.3	18.28	11.56	.55	9.91	13.25	10.00
RFK2-580-3.8	M5x0.8 ISO	.38	0.70	3.8	18.28	11.56	.55	9.91	13.25	10.00
RFK2-610-3.8	M6x1.0 ISO	.76	0.70	3.8	20.80	15.11	.55	13.46	16.00	13.50

## RFL INCH THREAD LARGE FLANGE SERIES (UNIT - INCHES)

Part Number Inch (Steel)	Thread Size	Radial Deflection	Grip Range		L ± .0215	HD ± .010	HT ± .003	D Max.	IL Ref.	Hole Size +.006/-0.000
			Min.	Max.						
RFL2-0632-130	6-32 UNC	.020	.027	.130	.7195	.500	.030	.390	.522	.391
RFL2-0832-130	8-32 UNC	.020	.027	.130	.7195	.500	.030	.390	.522	.391
RFL2-1032-150	10-32 UNF	.015	.027	.150	.7195	.500	.030	.390	.522	.391
RFL2-2520-150	1/4-20 UNC	.030	.027	.150	.8190	.685	.035	.530	.630	.531

## RFL METRIC THREAD LARGE FLANGE SERIES (UNIT - MILLIMETERS)

Part Number Metric (Steel)	Thread Size	Radial Deflection	Grip Range		L ± .55	HD ± .25	HT ± .08	D Max.	IL Ref.	Hole Size +.15/-0.000
			Min.	Max.						
RFL2-470-3.3	M4x0.7 ISO	.51	0.70	3.3	18.28	12.70	.76	9.91	13.25	10.00
RFL2-580-3.8	M5x0.8 ISO	.38	0.70	3.8	18.28	12.70	.76	9.91	13.25	10.00
RFL2-610-3.8	M6x1.0 ISO	.76	0.70	3.8	20.80	17.40	.89	13.46	16.00	13.50

RIV-FLOAT® is covered under US Patent No. 7,713,011

RIV-FLOAT®



- The RIV-FLOAT® series provides easy, accurate, and fast attachment of components in off-center applications.

CENTERING  
NOSEPIECE

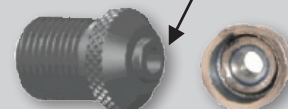

- The RIV-FLOAT® series should be installed with the FLEX-5 Hydro-Pneumatic Tool with a RIV-FLOAT® Anvil.



## RIV-FLOAT® SERIES

### TEST DATA

Thread Size	Material Thickness (Steel)	Pull Out	Failure Mode (Pull Out)	Torque Out	Failure Mode (Torque Out)	Suggested Assembly Torque Grade 5 Class 8.8
8-32 UNC	.130"	2205 lbf	Bolt Breaks	71 in-lb	Bolt Breaks	22.0 in-lb
10-32 UNF	.150"	3530 lbf	Bolt Breaks	128 in-lb	Bolt Breaks	36.0 in-lb
1/4-20 UNC	.150"	5510 lbf	Bolt Breaks	265 in-lb	Bolt Breaks	75.0 in-lb
M4x0.7 ISO	3.3 mm	1000 kgf	Bolt Breaks	9 N•m	Bolt Breaks	2.5 N•m
M5x0.8 ISO	3.8 mm	1900 kgf	Bolt Breaks	21 N•m	Bolt Breaks	5.0 N•m
M6x1.0 ISO	3.8 mm	2500 kgf	Bolt Breaks	30 N•m	Bolt Breaks	8.6 N•m

### RIV-FLOAT® RIVET NUT HAND TOOL KITS

	Inch Kit	Metric Kit	6-32 / 8-32 Mini Inch Kit	10-32 / 1/4-20 Mini Inch Kit
<b>Part Number:</b>	RNHT RF INCH KIT	RNHT RF METRIC KIT	RNHT 6-32/8-32 RF MINI KIT	RNHT 10-32/2520 RF MINI KIT
<b>Tools Sizes:</b>	6-32 to 1/4-20	M4 to M6	1/4-28	10-32 and 1/4-20
<b>Rivet Nuts:</b>	30 pieces of RFL2-0632-130	30 pieces of RFL2-470-3.3	20 pieces of RFL2-0632-130	20 pieces of RFL2-1032-150
	30 pieces of RFL2-0832-130	30 pieces of RFL2-580-3.8	20 pieces of RFL2-0832-130	10 pieces of RFL2-2520-150
	30 pieces of RFL2-1032-150	20 pieces of RFL2-610-3.8		
	20 pieces of RFL2-2520-150			

Each tool comes with an extra mandrel

### MECHANICALLY LOCKED PARTS

	Mechanically Locked Inch Kit	Mechanically Locked Metric Kit
<b>Part Number:</b>	RNHT RF ML INCH KIT	RNHT RF ML METRIC KIT
<b>Tools Sizes:</b>	1/4-28	1/4-28
<b>Rivet Nuts:</b>	20 pieces of SH-22-0632	20 pieces of SH-22-470
	20 pieces of SH-22-0832	20 pieces of SH-22-580
	20 pieces of SH-22-1032	

Each tool comes with an extra mandrel



### RIV-FLOAT® RIVET NUT HAND TOOL BAG

	6-32 BAG	8-32 BAG	10-32 BAG	1/4-20 BAG
<b>Part Number:</b>	RNHT-0632RF BAG	RNHT-0832RF BAG	RNHT-1032RF BAG	RNHT-2520RF BAG
<b>Tools Sizes:</b>	1/4-28	1/4-28	10-32	1/4-20
<b>Rivet Nuts:</b>	15 pieces of RFL2-0632-130	15 pieces of RFL2-0832-130	15 pieces of RFL2-1032-150	10 pieces of RFL2-2520-150

Each tool comes with an extra mandrel

	M4 BAG	M5 BAG	M6 BAG
<b>Part Number:</b>	RNHT-M4RF BAG	RNHT-M5RF BAG	RNHT-M6RF BAG
<b>Tools Sizes:</b>	1/4-28	M5	M6
<b>Rivet Nuts:</b>	15 pieces of RFL2-470-3.3	15 pieces of RFL2-580-3.8	10 pieces of RFL2-610-3.8

Each tool comes with an extra mandrel

### MECHANICALLY LOCKED PARTS

	Mechanically Locked 6-32 BAG	Mechanically Locked 8-32 BAG	Mechanically Locked 10-32 BAG
<b>Part Number:</b>	RNHT-0632RF ML BAG	RNHT-0832RF ML BAG	RNHT-1032RF ML BAG
<b>Tools Sizes:</b>	1/4-28	1/4-28	1/4-28
<b>Rivet Nuts:</b>	15 pieces of SH-22-0632	15 pieces of SH-22-0832	15 pieces of SH-22-1032

Each tool comes with an extra mandrel

### MECHANICALLY LOCKED PARTS

	Mechanically Locked M4 BAG	Mechanically Locked M5 BAG
<b>Part Number:</b>	RNHT-M4RF ML BAG	RNHT-M5RF ML BAG
<b>Tools Sizes:</b>	1/4-28	1/4-28
<b>Rivet Nuts:</b>	15 pieces of SH-22-470	15 pieces of SH-22-580

Each tool comes with an extra mandrel



Contact Sherex for Riv-Float® Short kits and bags

Contact Sherex for availability and lead times

Private label available upon request

RIV-FLOAT® is covered under US Patent No. 7,713,011

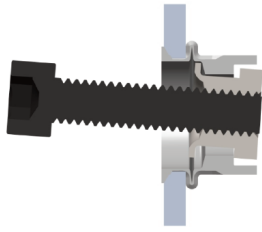

CROSS SECTION OF RIV-FLOAT®-SHORT Installed

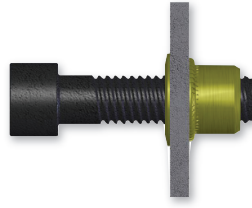

Standard Rivet Nut Installed

## FEATURES AND BENEFITS

- Accounts for tolerance stack up in joint design and misalignment during service of the joint.
- New Low-Profile design provides greater backside clearance.
- Allows for installation post finish in applications where riveted nut plates or cage nuts are typically used.
- Mechanically locked RIV-FLOAT®-Short available with prevailing torque feature to IFI SPEC 100/107.
- .020" Radial Float.
- RoHS Compliant.

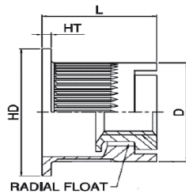

Uninstalled

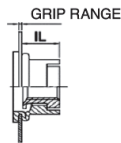

Installed

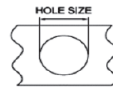

- The RIV-FLOAT® series provides easy, accurate, and fast attachment of components in off-center applications.

## RFSK INCH THREAD SMALL FLANGE SERIES (UNIT - INCHES)

Part Number Inch - Steel	Thread Size	Radial Float	Grip Range		L	HD	HT	D	IL	Hole Size
			Min.	Max.						
RFSK2-0832-100	8-32 UNC	0.020	.020	.100	.394	.480	.025	.431	.246	.433
RFSK2-1024-100	10-24 UNC	0.020	.020	.100	.394	.480	.025	.431	.246	.433
RFSK2-1032-100	10-32 UNF	0.020	.020	.100	.394	.480	.025	.431	.246	.433

## RFSK METRIC THREAD SMALL FLANGE SERIES (UNIT - MILLIMETERS)

SHEREX Part Number Metric - Steel	Thread Size	Radial Float	Grip Range		L	HD	HT	D	IL	Hole Size
			Min.	Max.						
RFSK2-470-2.5	M4x0.7 ISO	0.50	0.50	2.50	10.00	12.20	.63	10.95	6.25	11.00
RFSK2-580-2.5	M5x0.8 ISO	0.50	0.50	2.50	10.00	12.20	.63	10.95	6.25	11.00

## RFSL INCH THREAD LARGE FLANGE SERIES (UNIT - INCHES)

Part Number Inch - Steel	Thread Size	Radial Float	Grip Range		L	HD	HT	D	IL	Hole Size
			Min.	Max.						
RFSL2-0832-100	8-32 UNC	0.020	.020	.100	.406	.555	.033	.431	.246	.433
RFSL2-1024-100	10-24 UNC	0.020	.020	.100	.406	.555	.033	.431	.246	.433
RFSL2-1032-100	10-32 UNF	0.020	.020	.100	.406	.555	.033	.431	.246	.433

## RFSL METRIC THREAD LARGE FLANGE SERIES (UNIT - MILLIMETERS)

Part Number Metric - Steel	Thread Size	Radial Float	Grip Range		L	HD	HT	D	IL	Hole Size
			Min.	Max.						
RFSL2-470-2.5	M4x0.7 ISO	0.50	0.50	2.50	10.30	14.10	.85	10.95	6.25	11.00
RFSL2-580-2.5	M5x0.8 ISO	0.50	0.50	2.50	10.30	14.10	.85	10.95	6.25	11.00

RIV-FLOAT® Short is covered under U.S. Patent No. 9,309,914



## RIV-FLOAT® SHORT SERIES

## FLOATING TECHNOLOGIES

### RIV-FLOAT®-SHORT vs. Riveted Nut Plates vs. Cage Nuts

#### RIVETED NUT PLATE

- Requires three holes to be drilled (1 for the plate & 2 for the rivets).
- Requires access to both sides of the work piece.
- 15-20 second installation time.

#### CAGE NUT

- Requires a square hole to be punched.
- Requires access to both sides of the work piece.
- 15-20 second installation time.

#### RIV-FLOAT®-SHORT

- Only 1 round hole needs to be drilled.
- Access from only one side of the work is necessary for installation.
- 2-3 second installation time.

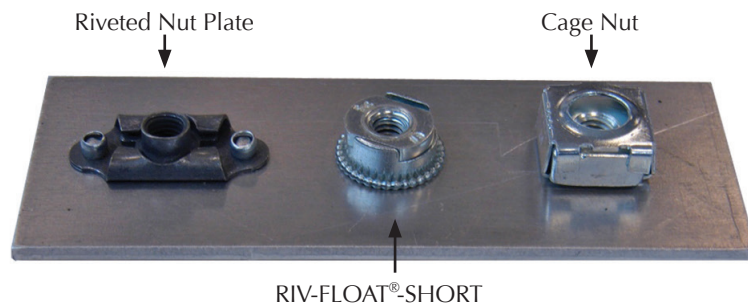

#### SINGLE KITS - RIV-FLOAT®-SHORT

- |                    |  |
|--------------------|--|
| • RNHT-0832RFS BAG | 1 Installation Tool, 1 Mandrel, 15 RIV-FLOAT®-SHORT rivet nuts |
| • RNHT-1032RFS BAG | 1 Installation Tool, 1 Mandrel, 15 RIV-FLOAT®-SHORT rivet nuts |
| • RNHT-M4RFS BAG   | 1 Installation Tool, 1 Mandrel, 15 RIV-FLOAT®-SHORT rivet nuts |
| • RNHT-M5RFS BAG   | 1 Installation Tool, 1 Mandrel, 15 RIV-FLOAT®-SHORT rivet nuts |

#### MULTI KITS - RIV-FLOAT®-SHORT

- |                      |  |
|----------------------|--|
| • RNHT RFS Inch Kit  | 1 Installation Tool for 8-32, 1 Mandrel, 1 Installation Tool for 10-32, 1 Mandrel, 1 Installation Tool for 1/4-20, 1 Mandrel, (30) 6-32, (30) 8-32, (30) 10-32 and (20) 1/4-20 Rivfloat Shorts |
| • RNHT RF Metric Kit | 1 Installation Tool for M4, 1 Mandrel, 1 Installation Tool for M5, 1 Mandrel, 1 Installation Tool for M6, 1 Mandrel, (40) M4, (30) M5 and (20) M6 Rivfloat Shorts                              |



RIV-FLOAT®-SHORT Rivet Nuts are designed to be installed with the FLEX-5 Hydro-Pneumatic Tool with a RIV-FLOAT®-SHORT Anvil.

RIV-FLOAT® Short is covered under U.S. Patent No. 9,309,914.

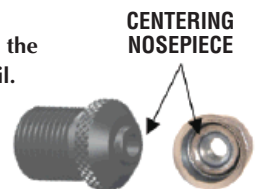



The first product line of its kind, offering Rivet Nuts up to 3/4-10 (M20)



**LARGE  
SIZE  
SERIES**

## FEATURES AND BENEFITS

- Provide a strong thread in thin sheet materials.
- Can be installed from one side of the work piece.
- Do not need to be welded to the base material.
- Available in a Round Body or a Full Hex Body for increased spin out resistance.
- Plated with a RoHS compliant Zinc Trivalent Clear plating.

## SIZES AND STYLES

- Unified Sizes Available:
  - 1/2" Thread Round Body & Hex Body
  - 5/8" Thread Round Body & Hex Body
  - 3/4" Thread Round Body
- Metric Sizes Available:
  - M12 Thread Round Body & Hex Body
  - M16 Thread Round Body & Hex Body



Large Size rivet nuts are designed to be installed with the Sherex Flex 18 (see page 45 for details).

**LARGE  
SIZE  
SERIES**

## Utility Pole Attachments

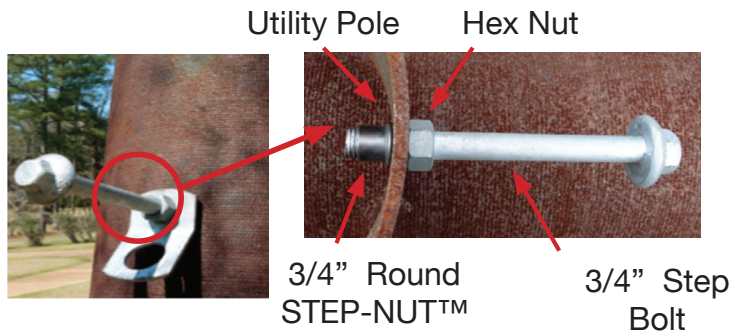

## Truck Frame Attachments

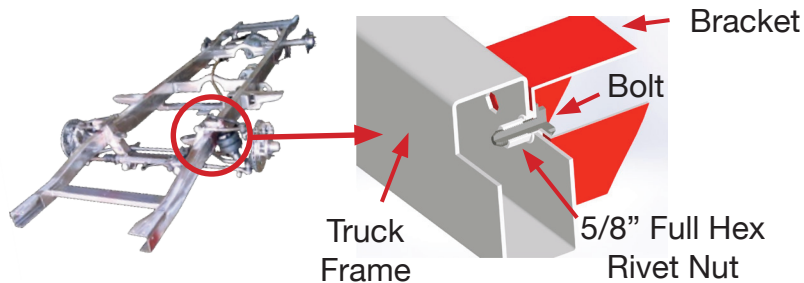

## Vending Machine Leg Leveler

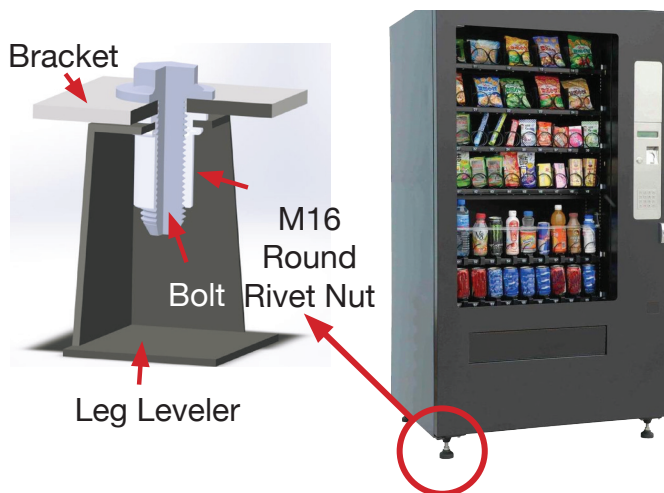

## Railcar Attachments

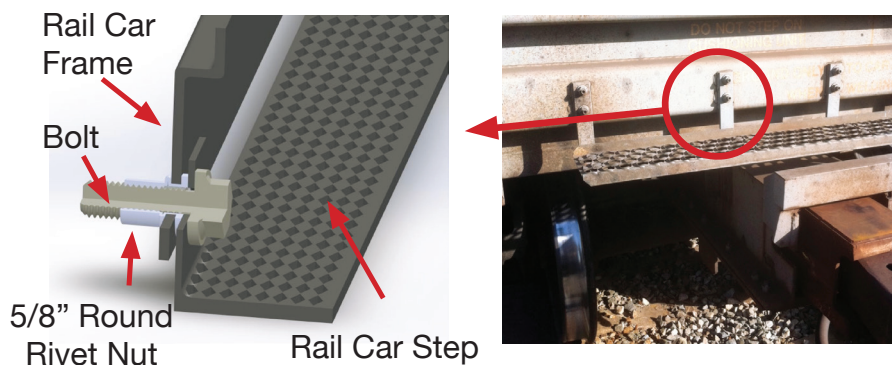

# LARGE SIZE RIVET NUT SERIES SPECIFICATIONS

**LARGE  
SIZE  
SERIES**

## Round Body

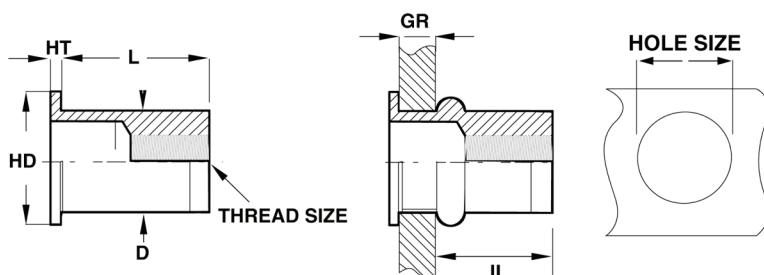

### LRGR SERIES - ROUND BODY UNIFIED THREAD (UNIT - INCHES)

Part Number Inch - Steel	Thread Size	Grip Range		L	HD	HT	D	IL	Hole Size
		Min.	Max.	± .015	± .025	± .004	Max.	Ref.	+ .010/- .000
LRGR2-5013-177	1/2-13 UNC	.050	.150	1.260	.945	.085	.656	.984	.656
LRGR2-6211-200	5/8-11 UNC	.080	.200	1.428	1.181	.098	.826	1.142	.827
LRGR2-7510-250	3/4-10 UNC	.048	.250	1.210	1.235	.118	.906	.878	.907

### LRGR SERIES - ROUND BODY METRIC THREAD (UNIT - MILLIMETERS)

Part Number Metric - Steel	Thread Size	Grip Range		L	HD	HT	D	IL	Hole Size
		Min.	Max.	± .38	± .64	± .10	Max.	Ref.	+ .25/- .000
LRGR2-12175-3.8	M12x1.75 ISO	1.27	3.80	32.00	24.00	2.16	16.65	25.00	16.66
LRGR2-1620-5.0	M16x2.0 ISO	2.00	5.00	36.27	30.00	2.50	20.98	29.00	21.00

## Full Hex Body

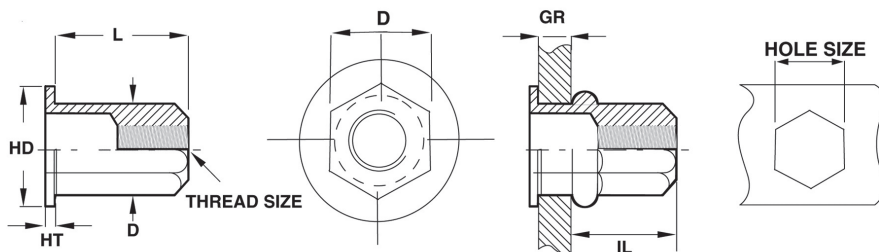

### LRGH SERIES - FULL HEX BODY UNIFIED THREAD (UNIT - INCHES)

Part Number Inch - Steel	Thread Size	Grip Range		L	HD	HT	D (A/F)	IL	Hole Size (A/F)
		Min.	Max.	± .015	± .025	± .004	Max.	Ref.	+ .010/- .000
LRGH2-5013-177	1/2-13 UNC	.040	.177	1.181	.959	.085	.656	.866	.656
LRGH2-6211-200	5/8-11 UNC	.080	.200	1.260	1.260	.118	.826	.965	.827

### LRGH SERIES - FULL HEX METRIC THREAD (UNIT - MILLIMETERS)

Part Number Metric - Steel	Thread Size	Grip Range		L	HD	HT	D (A/F)	IL	Hole Size (A/F)
		Min.	Max.	± .38	± .64	± .10	Max.	Ref.	+ .25/- .000
LRGH2-12175-4.5	M12x1.75 ISO	1.00	4.50	30.00	24.36	2.16	16.65	22.00	16.66
LRGH2-1620-5.0	M16x2.0 ISO	2.00	5.00	32.00	32.00	3.00	20.98	24.50	21.00

Material: Steel 108/1010

ROHS Compliant Finishes: Zinc plated – clear trivalent chromate per Sherex SFS-01-001

Sherex full hex rivet nuts are compatible with the following hardware:

GRADE 2, GRADE 5, CLASS 8.8 and CLASS 9.8

Please contact Sherex when using other grade fasteners.

\*Mechanical lock feature is available on all Full Hex parts.

Please contact Sherex for details.

## RIVET NUT STUDS



Sherex Rivet Nut Studs are another solution for thin sheet metal applications with blind installation requirements and are available in a variety of sizes, styles, materials, and finishes. Contact us with your thread size, length, and installation material thickness requirements.

### FEATURES AND BENEFITS

- Simple, blind installation
- Reduces processing cost of weld studs
- Eliminates risk of weld spatter and material distortion
- Eliminates cost of post installation paint process
- Can be used as a hanging point or centering pin
- Great for use in wire harnessing

### PRODUCT EXAMPLES

#### Wedge Head Stud



This M6 stud was developed for wire harnessing on a truck frame. The design incorporates a wedgehead feature for increased spin out resistance, and a MATHread(R)\* screw for reduced cross thread risk during assembly.

#### Full Hex Stud



This M12 Full Hex stud was developed as a replacement for a weld stud in an agricultural feeder.

### INSTALLATION

Sherex Rivet Nut studs can be installed with specially designed rivet nut stud headsets using our SSG and Flex series tools.



# NAS/MS FLAT HEAD STYLES

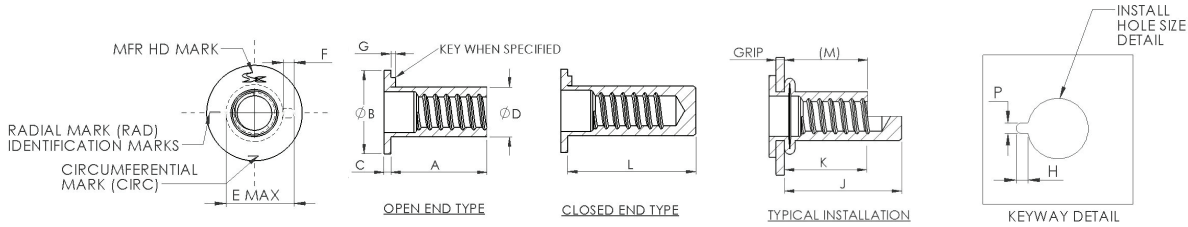

## NAS/MS FLAT HEAD STYLES

Produced in  
our AS9100  
Certified  
manufacturing  
facility in  
Akron, Ohio.



### UNIFIED THREAD (UNIT - INCHES)

THREAD SIZE	ØB +/- .015	C NOM	ØD +.000/- .004	INSTALL DRILL SIZE (REF)	INSTALL HOLE SIZE			F +.005/- .000	G MAX	KEYWAY DIMENSIONS		*PULL UP FACTOR
					MIN	MAX	E MAX			P +.003/- .000	H	
4-40 UNC-3B	0.270	0.025	0.155	5/32	.155	.157	0.198	0.054	0.023	0.062	.046 - .048	.055
6-32 UNC-3B	0.325	0.032	0.189	NO 12	.189	.193	0.240	0.054	0.023	0.062	.056 - .058	.065
8-32 UNC-3B	0.357	0.032	0.221	NO 2	.221	.226	0.271	0.054	0.023	0.062	.056 - .058	.065
10-24 UNC-3B 10-32 UNF-3B	0.406	0.038	0.250	E	.250	.256	0.302	0.054	0.023	0.062	.056 - .058	.080
1/4-20 UNC-3B 1/4-28 UNF-3B	0.475	0.058	0.332	Q	.332	.338	0.382	0.054	0.035	0.062	.056 - .058	.095
5/16-18 UNC-3B 5/16-24 UNF-3B	0.665	0.062	0.413	Z	.413	.423	0.505	0.120	0.040	0.128	.097 - .102	.120
3/8-16 UNC-3B 3/8-24 UNF 3B	0.781	0.088	0.490	12.5 MM	.490	.500	0.597	0.120	0.040	0.128	.110 - .115	.155
1/2-13 UNC-3B 1/2-20 UNF-3B	0.906	0.085	0.625	5/8	.625	.635	0.733	0.120	0.040	0.128	.110 - .115	.185

### PART NUMBERING SYSTEM

#### Example: SXS2528-80CY

SX	S	2528	( )	80	CY
Sherex NAS Part	Material <b>S-Steel</b> A-Aluminum SS- 430 Stainless Steel NM- 316 Stainless (Non-Magnetic) CH-Alloy Steel B-Brass	Thread Size	( ) - Open Ended Non Keyed B-Closed End K-Keyed R-Ribbed	Grip Range Ending in 0 or 5 denotes Flat Head  Ending in 1 or 6 denotes Countersunk Head	CY-Cadmium Yellow ZY-Zinc Yellow ML-Mechanical Lock



CLASSIFICATION PART STANDARD  
**7EK30**

Compliant to DFARS 252.225-7009

CLASSIFICATION PART STANDARD  
**4JQL4**



# NAS/MS FLAT HEAD STYLES

## NAS/MS FLAT HEAD STYLES

Produced in  
our AS9100  
Certified  
manufacturing  
facility in  
Akron, Ohio.

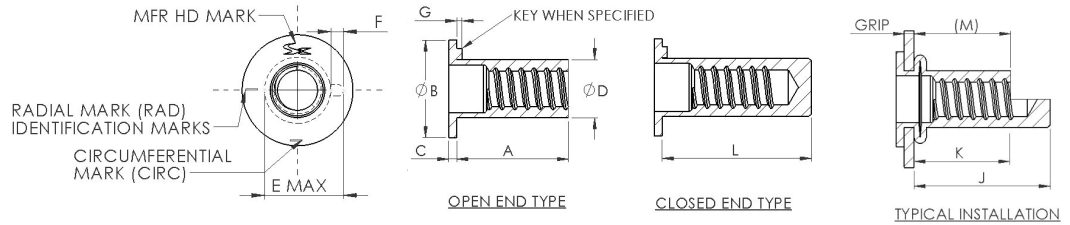

### UNIFIED THREAD (UNIT - INCHES)

PART NUMBER*	THREAD SIZE	GRIP RANGE	IDENTIFYING MARK	OPEN END KEYED AND KEYLESS		CLOSED END KEYLESS			CLOSED END KEYED		
				A +/- .015	M REF	L +/- .015	J NOM	K NOM	L +/- .015	J NOM	K NOM
SXS4-60CY	4-40 UNC-3B	.010-.060	BLANK	0.345	0.230	0.500	0.385	0.230	0.500	0.385	0.230
SXS4-85CY		.060-.085	1 RAD	0.370	0.230	0.525	0.385	0.230	0.525	0.385	0.230
SXS4-110CY		.085-.110	2 RAD	0.400	0.230	0.555	0.390	0.230	0.555	0.390	0.230
SXS4-135CY		.110-.135	3 RAD	0.425	0.230	0.580	0.385	0.230	0.580	0.385	0.230
SXS4-160CY		.135-.160	4 RAD	0.450	0.230	0.605	0.385	0.230	0.605	0.385	0.230
SXS4-185CY		.160-.185	5 RAD	0.480	0.230	0.635	0.385	0.230	0.635	0.385	0.230
SXS6-75CY	6-32 UNC-3B	.010-.075	1 RAD	0.438	0.300	0.625	0.490	0.305	0.750	0.615	0.405
SXS6-120CY		.075-.120	3 RAD	0.500	0.315	0.625	0.440	0.255	0.750	0.565	0.355
SXS6-160CY		.120-.160	5 RAD	0.500	0.270	0.750	0.520	0.260	0.750	0.520	0.310
SXS6-200CY		.160-.200	1 CIRC	0.562	0.290	0.750	0.480	0.260	0.750	0.480	0.260
SXS6-240CY		.200-.240	2 CIRC	0.625	0.310	0.750	0.435	0.260	0.750	0.435	0.260
SXS6-280CY		.240-.280	3 CIRC	0.687	0.330	0.812	0.455	0.265	0.812	0.455	0.265
SXS8-75CY	8-32 UNC-3B	.010-.075	1 RAD	0.438	0.300	0.625	0.490	0.305	0.750	0.615	0.405
SXS8-120CY		.075-.120	3 RAD	0.500	0.315	0.625	0.440	0.255	0.750	0.565	0.355
SXS8-160CY		.120-.160	5 RAD	0.500	0.270	0.750	0.520	0.260	0.750	0.520	0.310
SXS8-200CY		.160-.200	1 CIRC	0.625	0.350	0.750	0.475	0.265	0.750	0.475	0.265
SXS8-240CY		.200-.240	2 CIRC	0.625	0.305	0.875	0.555	0.310	0.875	0.555	0.310
SXS8-280CY		.240-.280	3 CIRC	0.687	0.340	0.875	0.530	0.290	0.875	0.530	0.290
SXS1024-80CY	10-24 UNC-3B	.010-.080	BLANK	0.531	0.380	0.781	0.630	0.380	0.781	0.630	0.380
SXS10-80CY	10-32 UNF-3B										
SXS10-130CY		.080-.130	1 RAD	0.594	0.390	0.843	0.640	0.390	0.843	0.640	0.390
SXS10-180CY		.130-.180	2 RAD	0.641	0.390	0.891	0.640	0.390	0.891	0.640	0.390
SXS10-230CY		.180-.230	3 RAD	0.703	0.395	0.953	0.645	0.395	0.953	0.645	0.395
SXS10-280CY		.230-.280	4 RAD	0.750	0.395	1.000	0.645	0.395	1.000	0.645	0.395
SXS10-330CY		.280-.330	5 RAD	0.797	0.385	1.047	0.630	0.385	1.047	0.630	0.385
SXS2528-80CY	1/4-28 UNF-3B	.020-.080	BLANK	0.625	0.450	0.937	0.760	0.440	0.937	0.760	0.440
SXS25-80CY	1/4-20 UNC-3B										
SXS25-140CY		.080-.140	1 RAD	0.687	0.450	1.000	0.760	0.440	1.000	0.760	0.440
SXS25-200CY		.140-.200	2 RAD	0.750	0.450	1.062	0.760	0.440	1.062	0.760	0.440
SXS25-260CY		.200-.260	3 RAD	0.812	0.445	1.125	0.755	0.445	1.125	0.755	0.445
SXS25-320CY		.260-.320	4 RAD	0.875	0.445	1.187	0.755	0.445	1.187	0.755	0.445
SXS25-380CY		.320-.380	5 RAD	0.937	0.445	1.250	0.755	0.445	1.250	0.755	0.445
SXS3124-125CY	5/16-24 UNF-3B	.030-.125	BLANK	0.750	0.505	1.187	0.940	0.550	1.187	0.940	0.550
SXS31-125CY	5/16-18 UNC-3B										
SXS31-200CY		.125-.200	1 RAD	0.875	0.555	1.281	0.960	0.555	1.281	0.960	0.555
SXS31-275CY		.200-.275	2 RAD	0.937	0.540	1.343	0.950	0.560	1.343	0.950	0.560
SXS31-350CY		.275-.350	3 RAD	1.032	0.560	1.437	0.965	0.570	1.437	0.965	0.570
SXS31-425CY		.350-.425	4 RAD	1.125	0.580	1.531	0.985	0.575	1.531	0.985	0.575
SXS31-500CY		.425-.500	5 RAD	1.187	0.565	1.593	0.975	0.580	1.593	0.975	0.580
SXS3724-115CY	3/8-24 UNF-3B	.030-.115	BLANK	0.844	0.585	1.281	1.020	0.660	1.281	1.020	0.660
SXS37-115CY	3/8-16 UNC-3B										
SXS37-200CY		.115-.200	1 RAD	0.938	0.595	1.375	1.030	0.670	1.375	1.030	0.670
SXS37-285CY		.200-.285	2 RAD	1.031	0.605	1.468	1.040	0.680	1.468	1.040	0.680
SXS37-370CY		.285-.370	3 RAD	1.125	0.615	1.562	1.050	0.690	1.562	1.050	0.690
SXS37-455CY		.370-.455	4 RAD	1.218	0.630	1.656	1.065	0.710	1.656	1.065	0.710
SXS37-540CY		.455-.540	5 RAD	1.312	0.635	1.750	1.075	0.715	1.750	1.075	0.715
SXS5020-150CY	1/2-20 UNF-3B	.050-.150	BLANK	0.906	0.605	1.328	1.030	0.605	1.328	1.030	0.605
SXS50-150CY	1/2-13 UNC-3B										
SXS50-250CY		.150-.250	1 RAD	1.031	0.630	1.453	1.055	0.630	1.453	1.055	0.630
SXS50-350CY		.250-.350	2 RAD	1.141	0.640	1.562	1.060	0.640	1.562	1.060	0.640
SXS50-450CY		.350-.450	3 RAD	1.250	0.650	1.671	1.070	0.650	1.671	1.070	0.650

\*Note: Part numbers reflect steel, open-end, non-keyed, with cadmium yellow plating only.  
Please refer to part numbering system outlined on page 35 for further configurations.



# NAS/MS COUNTERSUNK STYLES

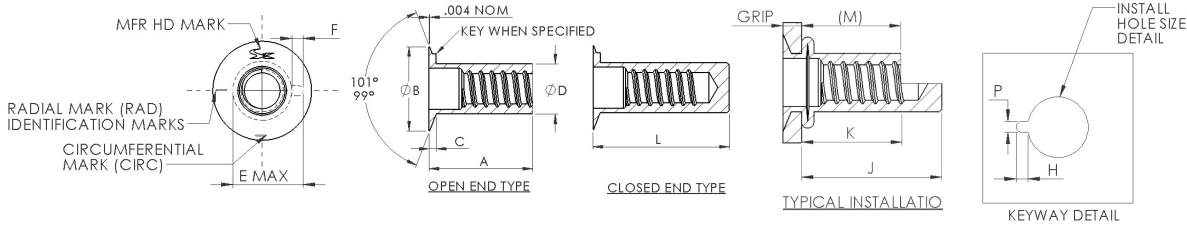

## UNIFIED THREAD (UNIT - INCHES)

THREAD SIZE	ØB +/- .015	C NOM	ØD +.000/- .004	INSTALL DRILL SIZE (REF)	INSTALL HOLE SIZE			F +.005/- .000	G MAX	KEYWAY DIMENSIONS		*PULL UP FACTOR
					MIN	MAX	E MAX			P +.003/- .000	H	
4-40 UNC-3B	0.270	0.025	0.155	5/32	.155	.157	0.198	0.054	0.023	0.062	.046 - .048	.055
6-32 UNC-3B	0.325	0.032	0.189	NO 12	.189	.193	0.240	0.054	0.023	0.062	.056 - .058	.065
8-32 UNC-3B	0.357	0.032	0.221	NO 2	.221	.226	0.271	0.054	0.023	0.062	.056 - .058	.065
10-24 UNC-3B 10-32 UNF-3B	0.406	0.038	0.250	E	.250	.256	0.302	0.054	0.023	0.062	.056 - .058	.080
1/4-20 UNC-3B 1/4-28 UNF-3B	0.475	0.058	0.332	Q	.332	.338	0.382	0.054	0.035	0.062	.056 - .058	.095
5/16-18 UNC-3B 5/16-24 UNF-3B	0.665	0.062	0.413	Z	.413	.423	0.505	0.120	0.040	0.128	.097 - .102	.120
3/8-16 UNC-3B 3/8-24 UNF 3B	0.781	0.088	0.490	12.5 MM	.490	.500	0.597	0.120	0.040	0.128	.110 - .115	.155
1/2-13 UNC-3B 1/2-20 UNF-3B	0.906	0.085	0.625	5/8	.625	.635	0.733	0.120	0.040	0.128	.110 - .115	.185

## PART NUMBERING SYSTEM

Example: **SXS2528-80CY**

SX	S	2528	( )	80	CY
Sherex NAS Part	Material <b>S-Steel</b> A-Aluminum SS- 430 Stainless Steel NM- 316 Stainless (Non-Magnetic) CH-Alloy Steel B-Brass	Thread Size	( ) - <b>Open Ended Non Keyed</b> B-Closed End K-Keyed R-Ribbed	Grip Range <b>Ending in 0 or 5 denotes Flat Head</b>  Ending in 1 or 6 denotes Countersunk Head	<b>CY-Cadmium Yellow</b> ZY-Zinc Yellow ML-Mechanical Lock



Produced in  
our AS9100  
Certified  
manufacturing  
facility in  
Akron, Ohio.



CLASSIFICATION PART STANDARD  
**7EK30**

Compliant to DFARS 252.225-7009

CLASSIFICATION PART STANDARD  
**4JQL4**



# NAS/MS COUNTERSUNK STYLES

## NAS/MS COUNTER- SUNK HEAD STYLES

Produced in  
our AS9100  
Certified  
manufacturing  
facility in  
Akron, Ohio.

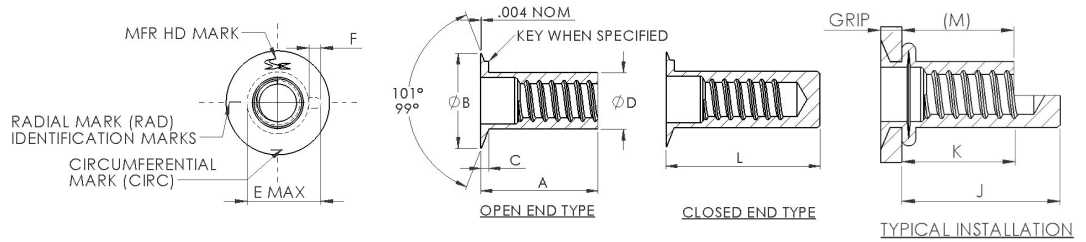

### UNIFIED THREAD (UNIT - INCHES)

PART NUMBER*	THREAD SIZE	GRIP RANGE	IDENTIFYING MARK	OPEN END KEYED AND KEYLESS		CLOSED END KEYLESS			CLOSED END KEYED		
				A +/- .015	M REF	L +/- .015	J NOM	K NOM	L +/- .015	J NOM	K NOM
SXS4-81CY	#4-40 UNC-3B	.050-.081	BLANK	0.370	0.235	0.525	0.390	0.235	0.525	0.390	0.235
SXS4-106CY		.081-.106	1 RAD	0.395	0.235	0.550	0.390	0.235	0.550	0.390	0.235
SXS4-131CY		.106-.131	2 RAD	0.420	0.235	0.575	0.390	0.235	0.575	0.390	0.235
SXS4-156CY		.131-.156	3 RAD	0.450	0.235	0.600	0.390	0.235	0.600	0.390	0.235
SXS4-181CY		.156-.181	4 RAD	0.475	0.235	0.625	0.390	0.235	0.625	0.390	0.235
SXS4-206CY		.181-.206	5 RAD	0.500	0.235	0.650	0.390	0.235	0.650	0.390	0.235
SXS6-106CY	#6-32 UNC-3B	.065-.106	BLANK	0.500	0.325	0.687	0.510	0.325	0.812	0.635	0.425
SXS6-161CY		.106-.161	2 RAD	0.500	0.280	0.687	0.465	0.280	0.812	0.590	0.380
SXS6-201CY		.161-.201	4 RAD	0.562	0.295	0.687	0.420	0.260	0.812	0.545	0.335
SXS6-241CY		.201-.241	1 CIRC	0.625	0.315	0.812	0.505	0.295	0.812	0.505	0.295
SXS6-281CY		.241-.281	2 CIRC	0.625	0.270	0.812	0.465	0.265	0.812	0.465	0.265
SXS6-321CY		.281-.321	3 CIRC	0.687	0.290	0.844	0.455	0.265	0.844	0.455	0.265
SXS8-106CY	#8-32 UNC-3B	.065-.106	BLANK	0.500	0.325	0.687	0.510	0.325	0.812	0.635	0.425
SXS8-161CY		.106-.161	2 RAD	0.500	0.280	0.687	0.465	0.280	0.812	0.590	0.380
SXS8-201CY		.161-.201	4 RAD	0.562	0.290	0.687	0.415	0.255	0.812	0.540	0.330
SXS8-241CY		.201-.241	1 CIRC	0.625	0.310	0.875	0.560	0.290	0.875	0.560	0.290
SXS8-281CY		.241-.281	2 CIRC	0.687	0.325	0.875	0.515	0.290	0.875	0.515	0.290
SXS8-321CY		.281-.321	3 CIRC	0.687	0.295	0.875	0.485	0.300	0.875	0.485	0.300
SXS1024-116CY	#10-24 UNC-3B	.065-.116	BLANK	0.578	0.395	0.828	0.645	0.395	0.828	0.645	0.395
SXS10-116CY	#10-32 UNF-3B										
SXS10-166CY		.116-.166	1 RAD	0.625	0.385	0.875	0.635	0.385	0.875	0.635	0.385
SXS10-216CY		.166-.216	2 RAD	0.687	0.400	0.938	0.650	0.400	0.938	0.650	0.400
SXS10-266CY		.216-.266	3 RAD	0.734	0.390	0.984	0.640	0.390	0.984	0.640	0.390
SXS10-316CY		.266-.316	4 RAD	0.781	0.385	1.031	0.635	0.385	1.031	0.635	0.385
SXS10-366CY		.316-.366	5 RAD	0.844	0.400	1.094	0.650	0.400	1.094	0.650	0.400
SXS2528-151CY	1/4-28 UNF-3B	.089-.151	BLANK	0.687	0.440	1.000	0.750	0.435	1.000	0.750	0.435
SXS25-151CY	1/4-20 UNC-3B										
SXS25-211CY		.151-.211	1 RAD	0.750	0.440	1.062	0.750	0.435	1.062	0.750	0.435
SXS25-271CY		.211-.271	2 RAD	0.812	0.440	1.125	0.750	0.435	1.125	0.750	0.435
SXS25-331CY		.271-.331	3 RAD	0.875	0.435	1.187	0.750	0.435	1.187	0.750	0.435
SXS25-391CY		.331-.391	4 RAD	0.937	0.435	1.250	0.750	0.435	1.250	0.750	0.435
SXS25-451CY		.391-.451	5 RAD	1.000	0.435	1.312	0.760	0.445	1.312	0.760	0.445
SXS3124-181CY	5/16-24 UNF-3B	.106-.181	BLANK	0.844	0.540	1.218	0.915	0.540	1.218	0.915	0.540
SXS31-181CY	5/16-18 UNC-3B										
SXS31-256CY		.181-.256	1 RAD	0.937	0.560	1.312	0.935	0.560	1.312	0.935	0.560
SXS31-331CY		.256-.331	2 RAD	1.000	0.550	1.406	0.955	0.550	1.406	0.955	0.550
SXS31-406CY		.331-.406	3 RAD	1.093	0.565	1.468	0.940	0.565	1.468	0.940	0.565
SXS31-481CY		.406-.481	4 RAD	1.156	0.555	1.562	0.960	0.555	1.562	0.960	0.555
SXS31-556CY		.481-.556	5 RAD	1.250	0.575	1.625	0.950	0.575	1.625	0.950	0.575
SXS3724-211CY	3/8-24 UNF-3B	.125-.211	BLANK	0.938	0.580	1.375	1.020	0.655	1.375	1.020	0.655
SXS37-211CY	3/8-16 UNC-3B										
SXS37-296CY		.211-.296	1 RAD	1.031	0.590	1.468	1.030	0.655	1.468	1.030	0.655
SXS37-381CY		.296-.381	2 RAD	1.125	0.600	1.562	1.040	0.675	1.562	1.040	0.675
SXS37-466CY		.381-.466	3 RAD	1.219	0.615	1.656	1.050	0.690	1.656	1.050	0.690
SXS37-551CY		.466-.551	4 RAD	1.312	0.625	1.750	1.065	0.705	1.750	1.065	0.705
SXS37-636CY		.551-.636	5 RAD	1.442	0.650	1.859	1.090	0.715	1.859	1.090	0.715
SXS5020-226CY	1/2-20 UNF-3B	.125-.226	BLANK	0.984	0.610	1.406	1.030	0.610	1.406	1.030	0.610
SXS50-226CY	1/2-13 UNC-3B										
SXS50-326CY		.226-.326	1 RAD	1.094	0.620	1.515	1.040	0.620	1.515	1.040	0.620
SXS50-426CY		.326-.426	2 RAD	1.218	0.640	1.625	1.050	0.640	1.625	1.050	0.640
SXS50-526CY		.426-.526	3 RAD	1.312	0.635	1.750	1.075	0.635	1.750	1.075	0.635

\*Note: Part numbers reflect steel, open-end, non-keyed, with cadmium yellow plating only.  
Please refer to part numbering system outlined on page 37 for further configurations.





# CAL KITS - LARGE FLANGE, KNURLED

## CAL KITS

### CAL RIVET NUT HAND TOOL KIT (UNIT - INCHES)

Part Number	CAL RNHT SML IN KIT	CAL RNHT LRG IN KIT
<b>Kit Contents</b>	50 pieces of CAL2-0632-080 40 pieces of CAL2-0832-080 40 pieces of CAL2-1032-130 1 RNHT-0632 Tool 1 RNHT-0832 Tool 1 RNHT-1032 Tool	30 pieces of CAL2-2520-165 20 pieces of CAL2-3118-150 20 pieces of CAL2-3716-150 1 RNHT-2520 Tool 1 RNHT-3118 Tool 1 RNHT-3716 Tool

### CAL RIVET NUT HAND TOOL KIT (UNIT - METRIC)

Part Number	CAL RNHT SML MET KIT	CAL RNHT LRG MET KIT
<b>Kit Contents</b>	50 pieces of CAL2-470-2.0 40 pieces of CAL2-580-3.3 1 RNHT-M4 Tool 1 RNHT-M5 Tool	30 pieces of CAL2-610-4.2 20 pieces of CAL2-8125-3.8 20 pieces of CAL2-1015-3.8 1 RNHT-M6 Tool 1 RNHT-M8 Tool 1 RNHT-M10 Tool



### CAL RIVET NUT KIT (UNIT - INCHES)

Part Number	CAL SML IN KIT	CAL LRG IN KIT
<b>Kit Contents</b>	50 pieces of CAL2-0632-080 40 pieces of CAL2-0832-080 40 pieces of CAL2-1032-130	30 pieces of CAL2-2520-165 20 pieces of CAL2-3118-150 20 pieces of CAL2-3716-150

### CAL RIVET NUT KIT (UNIT - METRIC)

Part Number	CAL SML MET KIT	CAL LRG MET KIT
<b>Kit Contents</b>	50 pieces of CAL2-470-2.0 40 pieces of CAL2-580-3.3	30 pieces of CAL2-610-4.2 20 pieces of CAL2-8125-3.8 20 pieces of CAL2-1015-3.8



# CAH KITS - LARGE FLANGE, HALF HEX

## CAH KITS

### CAH RIVET NUT HAND TOOL KIT (UNIT - INCHES)

Part Number	CAH RNHT SML IN KIT	CAH RNHT LRG IN KIT
<b>Kit Contents</b>	50 pieces of CAH2-0632-080 40 pieces of CAH2-0832-080 40 pieces of CAH2-1032-130 1 RNHT-0632 Tool 1 RNHT-0832 Tool 1 RNHT-1032 Tool	30 pieces of CAH2-2520-165 20 pieces of CAH2-3118-150 20 pieces of CAH2-3716-150 1 RNHT-2520 Tool 1 RNHT-3118 Tool 1 RNHT-3716 Tool

### CAH RIVET NUT HAND TOOL KIT (UNIT - METRIC)

Part Number	CAH RNHT LRG MET KIT
<b>Kit Contents</b>	30 pieces of CAH2-610-4.2 20 pieces of CAH2-8125-3.8 20 pieces of CAH2-1015-3.8 1 RNHT-M6 Tool 1 RNHT-M8 Tool 1 RNHT-M10 Tool

### CAH RIVET NUT KIT (UNIT - INCHES)

Part Number	CAH SML IN KIT	CAH LRG IN KIT
<b>Kit Contents</b>	50 pieces of CAH2-0632-080 40 pieces of CAH2-0832-080 40 pieces of CAH2-1032-130	30 pieces of CAH2-2520-165 20 pieces of CAH2-3118-150 20 pieces of CAH2-3716-150

### CAH RIVET NUT KIT (UNIT - METRIC)

Part Number	CAH LRG MET KIT
<b>Kit Contents</b>	30 pieces of CAH2-610-4.2 20 pieces of CAH2-8125-3.8 20 pieces of CAH2-1015-3.8



### LHF TOOLS

LHF 202 (Imperial Tool) Includes: 8-32, 10-24, and 1/4-20 head sets

LHF 202M (Metric Tool) Includes: M4, M5, and M6 head sets

This hand tool was designed to install any rivet nut ranging in size from 6-32 to 1/4-28 (M4-M6), and is ideal for small production work and prototyping.



#### STANDARD

Thread Size	Mandrel	Anvil
6-32	LHFM 0632	LHFA 0632
8-32	LHFM 0832	LHFA 0832
10-24	LHFM 1024	LHFA 10
10-32	LHFM 1032	LHFA 10
1/4-20	LHFM 2520	LHFA 25
1/4-28	LHFM 2528	LHFA 25
M4	LHFM M4	LHFA M4
M5	LHFM M5	LHFA M5
M6	LHFM M6	LHFA M6
M8	LHFM M8	LHFA M8
M10	LHFM M10	LHFA M10

#### RIV-FLOAT®

Thread Size	Mandrel	Anvil
6-32	LHFM 2528	LHFA 25
8-32	LHFM 2528	LHFA 25
10-32	LHFM 1032	LHFA 10RF
1/4-20	LHFM 2520	LHFA 25RF
M4	LHFM 2528	LHFA 25
M5	LHFM M5	LHFA M5RF
M6	LHFM M6	LHFA M6RF

#### RIV-FLOAT®-SHORT

Thread Size	Mandrel	Anvil
8-32	LHFM 0832	LHFM 0832RFS
10-32	LHFM 1032	LHFM 1032RFS
M4	LHFM M4	LHFM M4RFS
M5	LHFM M5	LHFM M5RFS

### DLHT AND DRHT TOOL (formerly M4 and M5 Hand Tool)

#### STANDARD

Thread Size	Head Sets (Includes Anvil & Mandrel)	Anvil	Mandrel
6-32	MHS-0632	MA-0632	M-0632
8-32	MHS-0832	MA-0832	M-0832
10-24	MHS-1024	MA-1024	M-1024
10-32	MHS-1032	MA-1032	M-1032
1/4-20	MHS-2520	MA-2520	M-2520
1/4-28	MHS-2528	MA-2528	M-2528
M4	MHS-M4	MA-M4	M-M4
M5	MHS-M5	MA-M5	M-M5
M6	MHS-M6	MA-M6	M-M6
M8	MHS-M8	MA-M8	M-M8
M10	MHS-M10	MA-M10	M-M10
M12	MHS-M12	MA-M12	M-M12

#### RIV-FLOAT®

Thread Size	Head Sets (Includes Anvil & Mandrel)	Anvil	Mandrel
8-32	MHS-0832RF	MA-2520/2528	M-2528
10-32	MHS-1032RF	MA-1032RF	M-1032
1/4-20	MHS-2520RF	MA-2520/2528RF	M-2520
M4	MHS-M4RF	MA-2520/2528	M-2528
M5	MHS-M5RF	MA-M5RF	M-M5
M6	MHS-M6RF	MA-M6RF	M-M6

#### RIV-FLOAT®-SHORT

Thread Size	Head Sets (Includes Anvil & Mandrel)	Anvil	Mandrel
8-32	MHS-0832RF	MA-0832RFS	M-0832
10-24	MHS-1024RFS	MA-10RF	M-1024
10-32	MHS-1032RF	MA-10RFS	M-1032
M4	MHS-M4RFS	MA-M4RFS	M-M4
M5	MHS-M5RFS	MA-M5RFS	M-M5



DLHT



DRHT

DLHT (Imperial Tool) Includes: 1/4-20, 5/16-18, 3/8-16, and 1/2-13 head sets

DLHT (Metric Tool) Includes: M6, M8, M10, and M12 head sets

DRHT (Imperial Tool) Includes: 10-32, 1/4-20, 5/16-18, and 3/8-16 head sets

DRHT (Metric Tool) Includes: M5, M6, M8, and M10 head sets

### RNHT TOOL



#### STANDARD

Part Number	Thread
RNHT-0632	6-32
RNHT-0832	8-32
RNHT-1024	10-24
RNHT-1032	10-32
RNHT-2520	1/4-20
RNHT-2528	1/4-28
RNHT-3118	5/16-18
RNHT-3124	5/16-24
RNHT-3716	3/8-16
RNHT-3724	3/8-24
RNHT-4320	7/16-20
RNHT-M3	M3
RNHT-M4	M4
RNHT-M5	M5
RNHT-M6	M6
RNHT-M8	M8

#### RIV-FLOAT®

Thread Size	Part Number
6-32	RNHT-2528RF
8-32	RNHT-2528RF
10-32	RNHT-1032RF
1/4-20	RNHT-2520RF
M4	RNHT-2528RF
M5	RNHT-M5RF
M6	RNHT-M6RF

#### RIV-FLOAT®-SHORT

Thread Size	Part Number
M4	RNHT-M4RFS
M5	RNHT-M5RFS

# RIVET NUT PNEUMATIC SPIN - SPIN TOOLS

## RIVET NUT PNEUMATIC SPIN - SPIN TOOLS

Designed for installing steel or aluminum CAL, CAK, CAH, CAO, CFT/CAT\*, CFW/CAW\* and CPB rivet nut inserts. Features quick change nose piece for head set replacement without tools.

\*Can install stainless steel.

**SSG-800**  
**PISTOL GRIP STYLE**



**SSG-910**  
**RIGHT ANGLE STYLE**



**SSG-900**  
**INLINE STYLE**



Part Number	Thread Size	Tool RPM		Air Pressure (Dynamic)	Weight	Air Inlet	Air Use	Minimum Hose Size	Complete Head Assembly	Hex Driver	Mandrel	Bearing Set	Complete Head Assembly Rivet Nut Stud
		<b>801&amp;901</b>	<b>911</b>	PSI	LBS	NPT	CFM	IN					
		Make Up Complete Head Assembly											
SSG - 801, 901 & 911	4-40	3000	2200	35-45	3.0	1/4"	5	3/8	HS-0440	HD-4	M-0440-150	BS-4	
	6-32	3000	2200	70-80	3.0	1/4"	5	3/8	HS-0632	HD-6	M-0632-150	BS-6	HSS-0632
	8-32	3000	2200	70-90	3.0	1/4"	5	3/8	HS-0832	HD-8	M-0832-150	BS-8	
	M3	3000	2200	35-45	3.0	1/4"	5	3/8	HS-M3	HD-M3	M-M3-30	BS-M3	
	M4	3000	2200	35-45	3.0	1/4"	5	3/8	HS-M4	HD-M4	M-M4-35	BS-M4	
		<b>802&amp;902</b>	<b>912</b>										
SSG - 802, 902 & 912	10-24	1500	1100	60-80	3.0	1/4"	5	3/8	HS-1024	HD-10	M-1024-175	BS-10	
	10-32	1500	1100	60-80	3.0	1/4"	5	3/8	HS-1032	HS-10	M-1032-175	BS-10	HSS-1032
	1/4-20	1500	1100	70-90	3.0	1/4"	5	3/8	HS-2520	HD-25	M-2520-175	BS-25	HSS-2520
	1/4-28	1500	1100	70-90	3.0	1/4"	5	3/8	HS-2528	HD-25	M-2528-200	BS-25	
	M5	1500	1100	60-80	3.0	1/4"	5	3/8	HS-M5	HD-M5	M-M5-40	BS-M5	HSS-M5
	M6	1500	1100	70-90	3.0	1/4"	5	3/8	HS-M6	HD-M6	M-M6-40	BS-M6	HSS-M6
		<b>803&amp;903</b>	<b>913</b>										
SSG - 803, 903 & 913	5/16-18	600	400	90-110	3.0	1/4"	5	3/8	HS-3118	HD-31	M-3118-175	BS-31	
	5/16-24	600	400	90-110	3.0	1/4"	5	3/8	HS-3124	HD-31	M-3124-175	BS-31	
	3/8-16	600	400	90-110	3.0	1/4"	5	3/8	HS-3716	HD-37	M-3716-200	BS-37	HSS-3716
	3/8-24	600	400	90-110	3.0	1/4"	5	3/8	HS-3724	HD-37	M-3724-200	BS-37	
	M8	600	400	90-110	3.0	1/4"	5	3/8	HS-M8	HD-M8	M-M8-40	BS-M8	HSS-M8
SSG - 804	5/16-18	400		90-110	3.0	1/4"	5	3/8	HS-3118	HD-31	M-3118-175	BS-31	
	5/16-24	400		90-110	3.0	1/4"	5	3/8	HS-3124	HD-31	M-3124-175	BS-31	
	3/8-16	400		90-110	3.0	1/4"	5	3/8	HS-3716	HD-37	M-3716-200	BS-37	
	3/8-24	400		90-110	3.0	1/4"	5	3/8	HS-3724	HD-37	M-3724-200	BS-37	
	M8	400		90-110	3.0	1/4"	5	3/8	HS-M8	HD-M8	M-M8-40	BS-M8	HSS-M8
SSG-808	1/2-13	275		75-120	4.0	1/4"	5	3/8	HS-5013	HD-50	M-5013-250	BS-50	
	1/2-20	275		75-120	4.0	1/4"	5	3/8	HS-5020	HD-50	M-5020-225	BS-50	
	M12	275		75-120	4.0	1/4"	5	3/8	HS-M12	HS-M12	M-M12-60	BS-M12	

\*Contact Sherex for Prebulbed (CPB) Mandrel part numbers

Contact Sherex for SSG Replacement part numbers.

\*Weight for 800 series only.

High temperature grease should be used to lubricate the bearing set. Contact Sherex for availability.

Sherex recommends the use of an air regulator, air filter, and lubrication system to reduce the wear of internal components. It is also recommended to lubricate the mandrel to increase performance. Mandrels should be replaced when excessive thread wear occurs with a high quality socket head cap screw.

# RIVET NUT HYDRO-PNEUMATIC FLEX-5 TOOL

## One Tool With Pull to Pressure & Pull to Stroke Capabilities



**FLEX-5P:** The Sherex FLEX-5P utilizes a Pull to Pressure method of installation. This method allows the same insert type to be installed into varying material thicknesses (within the Grip Range of the part) without any adjustment to the tool.



**FLEX-5S:** The Sherex FLEX-5S utilizes a Pull to Stroke method of installation. This method allows the insert to be installed to the same distance each time. This is helpful when installing into soft materials (prevents crushing of the base material) or when a specific Installed Length is required.

View our FLEX-5 Tool Demonstrations at [www.sherex.com](http://www.sherex.com)

**FLEX-5  
TOOL**



### FEATURES AND BENEFITS

#### Change over kit for converting between pull to pressure and pull to stroke

- Installs Rivet Nuts from: M3-M10 and 4-40-3/8-16.
- Push to start nose piece to spin on fastener.
- Single stage trigger.
- Automatic reverse with manual reverse bypass.
- Quick change mandrel design.
- Light weight (4.2 lbs).
- Can be suspended from a balancer.
- Socket head cap screw mandrel.
- Installs Rivet Nut Studs from M5-M8 and 10-24-5/16-24.
- Available in an in-line version.
- Split tool available (remote booster for lighter tool).
- Upgradeable to process monitoring.
- 5,000 lbs (22 kN) pulling force at 90 psi.
- 7 mm (0.276 in.) of available stroke.
- 2-3 second cycle time.
- All aluminum design for improved durability.

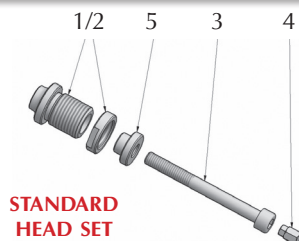

### HEAD SETS FOR STANDARD RIVET NUTS

Thread Size	Complete Headset	Anvil (1 + 2)	Mandrel (3)	Hex Driver (4)	Reducing sleeve (5)
M 3	FL5 - HS - M3	FL5 - HS - 00903	M -M3 -40	FL5 - HS - 01003	FL5 - HS - 09103
M 4	FL5 - HS - M4	FL5 - HS - 00904	M -M4 - 55	FL5 - HS - 01004	FL5 - HS - 09104
M 5	FL5 - HS - M5	FL5 - HS - 00905	M -M5 - 65	FL5 - HS - 01005	FL5 - HS - 09105
M 6	FL5 - HS - M6	FL5 - HS - 00906	M -M6 - 65	FL5 - HS - 01006	FL5 - HS - 09106
M 8	FL5 - HS - M8	FL5 - HS - 00908	M -M8 - 65	FL5 - HS - 01008	FL5 - HS - 09108
M 10	FL5 - HS - M10	FL5 - HS - 00910	M -M10 - 65	FL5 - HS - 01010	n/a
4 - 40 UNC	FL5 - HS - 0440	FL5 - HS - 00854	M -0440 - 175	FL5 - HS - 00754	FL5 - HS - 09154
6 -32 UNC	FL5 - HS - 0632	FL5 - HS - 00856	M -0632 - 175	FL5 - HS - 00756	FL5 - HS - 09156
8 -32 UNC	FL5 - HS - 0832	FL5 - HS - 00858	M -0832 - 175	FL5 - HS - 00758	FL5 - HS - 09158
10-24 UNC	FL5 - HS - 1024	FL5 - HS - 00850	M -1024 - 250	FL5 - HS - 00750	FL5 - HS - 09150
10-32 UNF	FL5 - HS - 1032	FL5 - HS - 00850	M -1032 - 250	FL5 - HS - 00750	FL5 - HS - 09150
1/4-20 UNC	FL5 - HS - 2520	FL5 - HS - 00848	M -2520 - 250	FL5 - HS - 00748	FL5 - HS - 09148
1/4-28 UNF	FL5 - HS - 2528	FL5 - HS - 00848	M -2528 - 250	FL5 - HS - 00748	FL5 - HS - 09148
5/16-18 UNC	FL5 - HS - 3118	FL5 - HS - 00840	M -3118 - 250	FL5 - HS - 00740	FL5 - HS - 09140
5/16-24 UNF	FL5 - HS - 3124	FL5 - HS - 00840	M -3124 - 250	FL5 - HS - 00740	FL5 - HS - 09140
3/8-16 UNC	FL5 - HS - 3716	FL5 - HS - 00842	M -3716 - 250	FL5 - HS - 00742	n/a
3/8-24 UNF	FL5 - HS - 3724	FL5 - HS - 00842	M -3724 - 250	FL5 - HS - 00742	n/a

# RIVET NUT HYDRO-PNEUMATIC FLEX-5 TOOL & MS 100 TOOL

## FLEX-5 TOOL

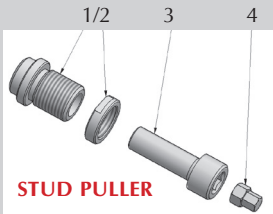

### HEAD SETS FOR RIVET NUT STUDS

Thread Size	Complete Headset	Anvil (1 + 2)	Mandrel (3)	Hex Driver (4)	Reducing sleeve (5)
M5	FL5 - HS - M5S	FL5 - HS - S0905	FL5 - HS - 0S005	FL5 - HS - 01010	n/a
M6	FL5 - HS - M6S	FL5 - HS - S0906	FL5 - HS - 0S006	FL5 - HS - 01010	n/a
M8*	FL5 - HS - M8S	FL5 - HS - S0908	FL5 - HS - 0S008	FL5 - HS - 01010	n/a
10-24 UNC	FL5 - HS - 1024S	FL5 - HS - S0850	FL5 - HS - S1024	FL5 - HS - 01010	n/a
10-32 UNF	FL5 - HS - 1032S	FL5 - HS - S0850	FL5 - HS - S1032	FL5 - HS - 01010	n/a
1/4-20 UNC	FL5 - HS - 2520S	FL5 - HS - S0848	FL5 - HS - S2520	FL5 - HS - 01010	n/a
1/4-28 UNF	FL5 - HS - 2528S	FL5 - HS - S0848	FL5 - HS - S2528	FL5 - HS - 01010	n/a
5/16-18 UNC*	FL5 - HS - 3118S	FL5 - HS - S0840	FL5 - HS - S3118	FL5 - HS - 01010	n/a
5/16-24 UNF*	FL5 - HS - 3124S	FL5 - HS - S0840	FL5 - HS - S3124	FL5 - HS - 01010	n/a

\*Head sets include p/n FL5-HS-12S92 adaptor nut

### HEAD SETS FOR RIV-FLOAT®

Thread Size	Complete Headset	Anvil (1 + 2)	Mandrel (3)	Hex Driver (4)	Reducing sleeve (5)
M4	FL5-HS-2528R	FL5-HS-00848	M-2528-225	FL5-HS-00748	FL5-HS-09148
M5	FL5-HS-M5R	FL5-HS-R0995	M-M5-65	FL5-HS-01005	FL5-HS-09105
M6	FL5-HS-M6R	FL5-HS-R0996	M-M6-65	FL5-HS-01006	FL5-HS-09106
4-40 UNC	FL5-HS-2528R	FL5-HS-00848	M-2528-225	FL5-HS-00748	FL5-HS-09148
6-32 UNC	FL5-HS-2528R	FL5-HS-00848	M-2528-225	FL5-HS-00748	FL5-HS-09148
8-32 UNC	FL5-HS-2528R	FL5-HS-00848	M-2528-225	FL5-HS-00748	FL5-HS-09148
10-24 UNC	FL5-HS-1024R	FL5-HS-R0950	M-1024-250	FL5-HS-00750	FL5-HS-09150
10-32 UNF	FL5-HS-1032R	FL5-HS-R0950	M-1032-250	FL5-HS-00750	FL5-HS-09150
1/4-20 UNC	FL5-HS-2520R	FL5-HS-R0948	M-2520-250	FL5-HS-00748	FL5-HS-09148
1/4-28 UNF	FL5-HS-2528R1	FL5-HS-R0948	M-2528-250	FL5-HS-00748	FL5-HS-09148

### HEAD SETS FOR RIV-FLOAT®-SHORT

Thread Size	Complete Headset	Anvil (1 + 2)	Mandrel (3)	Hex Driver (4)	Reducing sleeve (5)
M4	FL5-HS-M4SR	FL5-HS-SR0994	M-M4-55	FL5-HS-01004	FL5-HS-09104
M5	FL5-HS-M5SR	FL5-HS-SR0995	M-M5-65	FL5-HS-01005	FL5-HS-09105
8-32 UNC	FL5-HS-0832SR	FL5-HS-SR0858	M-0832-150	FL5-HS-00758	FL5-HS-09158
10-24 UNC	FL5-HS-1024SR	FL5-HS-SR0950	M-1024-225	FL5-HS-00750	FL5-HS-09150
10-32 UNF	FL5-HS-1032SR	FL5-HS-SR0950	M-1032-225	FL5-HS-00750	FL5-HS-09150

### MS 100 RIVET NUT TOOL

MS100		
Thread Size	Mandrel	Anvil
5/16-18	MA-373-3118	MA-369-3118
5/16-24	MA-377-3124	MA-369-3118
3/8-16	MA-374-3716	MA-370-3716
3/8-24	MA-378-3724	MA-370-3716
7/16-14	MA-375-4314	MA-371-4314
7/16-20	MA-301-4320	MA-371-4314
1/2-13	MA-376-5013	MA-372-5013
1/2-20	MA-379-5020	MA-372-5013
M8	MA-308-08MM	MA-318-08MM
M10	MA-310-10MM	MA-320-10MM
M12	MA-312-12MM	MA-322-12MM
M14	MA-314-14MM	MA-324-14MM

The MS 100 Rivet Nut installation tool installs rivet nuts from 5/16-18 to 1/2-20 and M8 to M14. It also installs 5/16 -18 and M8 Riv-Float®. The MS 100 tool comes with one mandrel and one anvil.

The MS 100 Rivet Nut installation tool should be operated at 80-100 psi. Sherex recommends the use of an air regulator, air filter and lubrication system to reduce the wear of internal components. It is also recommended to lubricate the mandrel to increase performance. Mandrels should be replaced when excessive thread wear occurs.



# RIVET NUT HYDRO-PNEUMATIC FLEX - 18 TOOL



## FEATURES AND BENEFITS

The most powerful tool on the market providing Pull to Pressure and Pull to Stroke installation capabilities.

- Installs Rivet Nuts from M8 to M16 and 5/16-18 to 3/4-10.
- Push to start nose piece to spin on fastener.
- Single stage trigger.
- Automatic reverse with manual reverse bypass.
- Quick change mandrel design.
- Socket head cap screw mandrel for sizes up to M12 and 1/2-20.
- Can be suspended from a balancer.
- **18,000 lbs. (80 kN) of pulling force.**
- **15 mm (.591 in) of available stroke.**
- Upgradeable to process monitoring.
- 2-3 second cycle time.
- Light weight handle (8.0 lbs.).
- All aluminum handle design for improved durability.

**FLEX-18  
TOOL**

## HEAD SETS FOR STANDARD SIZE NOSE CASE

Thread Size	Complete Headset	Anvil	Mandrel	Hex Driver	Adaptor Nut
M8	FL18 - HS -M8	FL18 - HS -00908	M-M8 -65	FL5 - HS -010 08	FL18 - HS -09108
M10	FL18 - HS -M10	FL18 - HS -00910	M-M10-65	FL5 - HS -01010	FL18 - HS -09110
M12	FL18 - HS -M12	FL18 - HS -00912	M-M12-65	FL18 - HS -01012	FL18 - HS -09112
5/16-18 UNC	FL18 - HS -3118	FL18 - HS -00908	M-3118 -250	FL5 - HS -00740	FL18 - HS -09108
5/16-24 UNF	FL18 - HS -3124	FL18 - HS -00908	M-3124 -250	FL5 - HS -00740	FL18 - HS -09108
3/8-16 UNC	FL18 - HS -3716	FL18 - HS -00910	M-3716 -300	FL5 - HS -00742	FL18 - HS -09110
3/8-24 UNF	FL18 - HS -3724	FL18 - HS -00910	M-3724 -300	FL5 - HS -00742	FL18 - HS -09110
1/2-13 UNC	FL18 - HS -5013	FL18 - HS -00950	M-5013 -300	FL18 - HS -00750	FL18 - HS -09150
1/2-20 UNF	FL18 - HS -5020	FL18 - HS -00950	M-5020 -300	FL18 - HS -00750	FL18 - HS -09150

## HEAD SETS FOR LARGE SIZE NOSE CASE

Thread Size	Complete Headset	Anvil	Mandrel
M16	FL18 - HS -M16	FL18 - HS -00916	M-M16-FL 18
5/8-11 UNC	FL18 - HS -6211	FL18 - HS -00962	M-6211 -FL18
3/4-10 UNC	FL18 - HS -7510	FL18 - HS -00975	M-7510 -FL18

View our FLEX-18 tool demonstration at [www.Sherex.com](http://www.Sherex.com)

Contact Sherex for more information on Process Monitoring Tools.

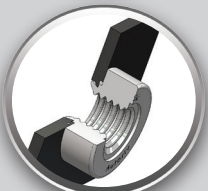

## FASTENING SYSTEMS ENGINEERED FOR PERFORMANCE™ Benefits of Full Hex Rivet Nuts vs. Welded Hex Fasteners

### The challenge:

A manufacturer of agricultural equipment was experiencing insufficient throughput rates in its baler product lines.

- The issue was determined to be a result of the welding process used in the numerous attachment points.
- The manufacturer wanted to improve the work environment by reducing the amount of emissions and vapors caused by the welding process.

### The solution:

Working directly with the manufacturer, the Sherex engineering team designed a new line of full hex rivet nuts to meet the application performance requirements.

- The new full hex rivet nuts significantly increased the application spin out resistance during installation.
- Sherex provided a complete installation solution to the customer: full hex rivet nuts and the FLEX-5 tool.
- This new process replaced the previous welding process, increasing throughput by 50%.

- Additionally, the new solution eliminated all emissions and vapors associated with the welding process, which led to a safer working environment for the assemblers.

### The savings:

Annual usage of the rivet nuts: 1,000,000

**Cost savings: \$0.12 per weld = \$120,000 annual savings!**

Sherex is a global manufacturer with a unique market approach in engineered fastening solutions that combines fasteners, tooling, and automation to deliver the best solution at the **lowest total installed cost**.



## Benefits of In-Die Fastener Installation vs. Welded Fastener Methods

### The challenge:

A manufacturer of automotive safety systems was experiencing a high fallout rate at the attachment point of the seat belt retractor assembly.

- The failure was determined to be a result of the secondary welding process that was required to attach the nut to the sheet metal component.
- This process caused a very high percentage of thread damage and distortion of the welded nut.

### The solution:

Sherex introduced the manufacturer to an MDS automation in-die fastener installation system.

- By utilizing the MDS automation installation system and incorporating a clinch nut design into the seat rail, the manufacturer was able to produce the sheet metal stamping and place the fastener in the same operation.
- This improvement eliminated the welding process that caused the thread damage.

- The new clinch nut automated process simplified the component manufacturing process by reducing the number of required steps and reduced on-site inventory.

### The savings:

Annual part assemblies: 450,000

**Cost savings: \$0.37 per part = \$166,500 annual savings!**

Sherex is a global manufacturer with a unique market approach in engineered fastening solutions that combines fasteners, tooling, and automation to deliver the best solution at the **lowest total installed cost**.



*These are illustrative examples of actual experiences and are intended for sales purposes only.*



### PULL OUT

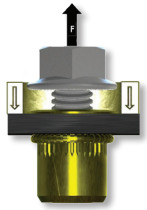

**Definition:**

- Pull Out occurs when threads are pulled from the rivet nut (ultimate thread strength) or base material is distorted and the entire rivet nut pulls through the base material.

**Causes:**

- Hole size is too large.
- Forces applied to the joint are higher than anticipated.

### SPIN OUT

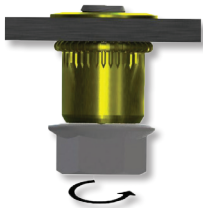

**Definition:**

- Spin Out is the amount of torque required to make a rivet nut spin in the hole in which it was installed.

**Causes:**

- Bolt cross threads into the rivet nut causing it to spin.
- Excessive corrosion causes bolt to bind in the nut.
- Using a screw with mechanical locking feature that has higher prevailing torque than the spin out of the rivet nut.

### TORQUE OUT

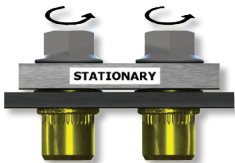

**Definition:**

- Torque force required to strip threads out of the rivet nut.
- This method of testing sandwiches the head of the rivet nut between the non-rotational mating part and parent or base panel.
- Spin Out is not a factor because tightening the bolt on the non-rotating part holds the rivet nut in place and prevents it from spinning.

**Causes:**

- Assembly torque is too high causing thread failure.
- Improper grade of fastener used.

\*Torque can be affected by various factors such as coefficient of friction of the finish, prevailing torque, washers, etc. Sherex recommends you test your application.

### SUGGESTED ASSEMBLY TORQUE

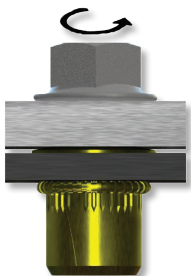

**Definition:**

- Recommended torque for assembling a rivet nut joint with Class 8.8/Grade 5 hardware.

**Contact Sherex should you require Grade 8, Class 10 or higher joint strength.**

THREAD SIZE	SUGGESTED ASSEMBLY TORQUE
	INCH LBS. -Nm PLATED SCREW GRADE 5 CLASS 8.8
# 6-32 UNC	12
# 8-32 UNC	22
# 10-24 UNC	32
# 10-32 UNF	36
1/4-20 UNC	75
1/4-28 UNF	75
5/16-18 UNC	156
5/16-24 UNC	156
3/18-16 UNC	276
3/8-24 UNF	276
M4x0.7 ISO	2.5
M5x0.8 ISO	5.0
M6x1.0 ISO	8.6
M8x1.25 ISO	21.0
M10x1.5 ISO	42.0
M12x1.75 ISO	72.0

TEST DATA IS FOR REFERENCE ONLY.

SHEREX RECOMMENDS TESTING YOUR APPLICATION FOR AN EXACT FIGURE.

# SHEREX PRODUCT MATRIX

Product Line	Body Style					Standard Head Styles				Available Modifications		Application Base Material				Proof Load Performance	Other	Performance	
	Round, Smooth	Round, Knurled	Slotted	Half Hex	Full Hex	Small Flange	Large Flange	Flat	Counter-sunk	Closed End	Sealed Head	Plastics	Hard Steel	Thick Steel (>.5")	Aluminum	Class 8 Proof Load	RoHs Compliant	Spin Out	Pull Out
CAL		X					X			X	X	R <sup>1</sup>	P-	P	P+		Yes	C	C
CAK		X				X				X		NR	P-	P	P+		Yes	C	C
CAH				X			X			X	X	P <sup>1</sup>	R	P+	R		Yes	B	C
CA	X						X	X	X	X		P <sup>1</sup>	P-	P	P		Yes	C	A
CAO	X					X				X		NR	P-	P	P		Yes	C	C
FHK					X	X				X	X	NR	R	P+	R	X	Yes	A	A
FHL					X		X	X		X	X	P*	R	P+	R	X	Yes	A	A
CFW		X <sup>DIAMOND</sup>				X						P-	P-	R	P		Yes	C	C
CAW		X <sup>DIAMOND</sup>				X						P-	P-	R	P		No	C	C
CFT		X				X						NR	P-	R	P		Yes	C	C
CAT		X				X						NR	P-	R	P		No	C	C
CPB	X		X				X	X				R <sup>1</sup>	NR	P	P		Yes	C	A
CPN	X		X				X	X				P <sup>1</sup>	NR	P	P		Yes	C	A
CFH					X		X	X		X	X	P <sup>1</sup>	R	P+	R		Yes	A	A
CFHD					X		X	X		X	X	P <sup>1</sup>	R	P+	R		Yes	A	A
LRGR	X						X	X		X	X	R <sup>1</sup>	P-	P	P+	X	Yes	C	C
LRGH					X		X	X		X	X	P <sup>1</sup>	R	P+	R	X	Yes	A	A
RFL		X					X			X	X	R <sup>1</sup>	P-	P	P+		Yes	A	A
RFK		X				X				X		NR	P-	P	P+		Yes	A	A
RFSL		X					X				X	R <sup>1</sup>	P-	P	P+		Yes	A	A
RFSK		X				X						NR	P-	P	P+		Yes	A	A
UPO	X						X	X	X	X	X	P <sup>1</sup>	P	P	P		Yes	C	B
UFO	X						X		X	X		P <sup>1</sup>	P	p	P		Yes	C	B
UKO	X					X		X	X	X		NR	P	p	P		Yes	C	B
HUPO					X <sup>2</sup>		X	X	X	X	X	P <sup>1</sup>	R	P+	R		Yes	A	A
HUKO					X <sup>2</sup>	X		X	X	X		NR	R	P+	R		Yes	A	A
UPO RS		X					X	X	X	X	X	R <sup>1</sup>	P-	P	P+		Yes	C	B
UFO RS		X					X		X	X		P <sup>1</sup>	P-	P	P+		Yes	C	B
CLM		X					X			X	X	R <sup>1</sup>	P-	P	P+		Yes	C	B
CKM		X				X				X		NR	P-	P	P+		Yes	C	B
SX	X						X	X	X	X	X	P*	P	P	P		No	C	A

Rivet nut studs in all product styles (excludes CAT, CAW, CFT, and CFW lines) are available by custom order.

- 1) May require special design features in plastics.
- 2) Stainless and carbon steel only, stainless steel HUPO/HUKO parts are half hex.

A: High  
B: Medium  
C: Low

R: Recommended  
P+: Possible, higher performance  
P: Possible  
P-: Possible, lower performance  
NR: Not recommended

## CUSTOM PRODUCT SHOWCASE

Sherex has the capability to create custom products for our customers; our in-house engineering and manufacturing teams work with customers to create specialized fastening solutions. Here are some examples of custom products created by Sherex:



This Dejong® part was designed with a “compression limiter-like” collar on the flat head, used to act as a spacer between two assembled components.

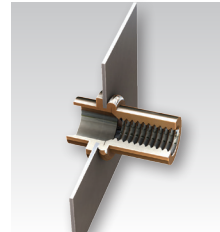

Was developed to attach a molded plastic cover to a base unit. If the rivet nut has an outside thread to accept a nut, the plastic cover could be altered and the external thread of the rivet nut could be used for the attachment point.

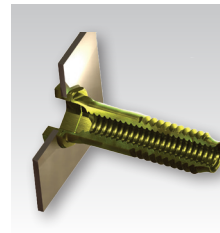

Designed with an extra large head to act like a spacer.

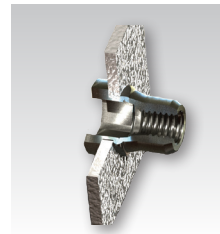

Sherex developed this part to add increased spin out resistance in soft materials. Special knurl design provides increased engagement with the base material. Small flange provided near flush installation.

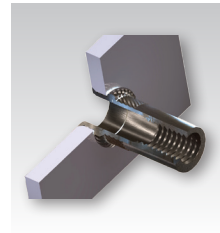

Special small grip part designed for materials thinner than .030 inches.

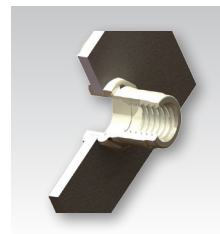

A replacement for a more expensive, machined component that would periodically spin-out. The customer required a low-profile insert with high spin-out resistance. Sherex developed this part has a half-hex body to increase spin performance, 0.145” max installed length, and higher strength threads to withstand installation forces.

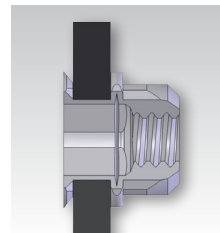

\* MATHread® is a registered trademark of MATHread Inc.

## CUSTOM PRODUCT SHOWCASE

Sherex has the capability to create custom products for our customers; our in-house engineering and manufacturing teams work with customers to create specialized fastening solutions. Here are some examples of custom products created by Sherex:

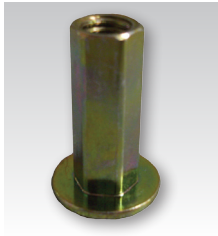

Sherex developed a high strength rivet nut that is compatible with class 10.9 bolts. This design incorporates a full hex body for increased spin out resistance. It also ensures the bolt is the failure mode, which is a best practice when working with structural applications.

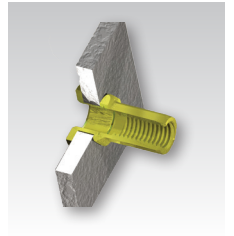

Special head and wedge design to meet spin-out requirements in an application.

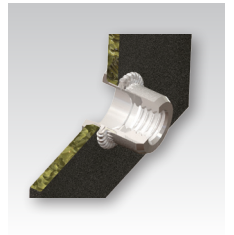

Sherex shouldered rivet nut was developed for attachments in plastics. The shoulder design provides a positive metal to metal installation redirecting the load of the joint through the rivet nut shoulder. This minimizes the plastic from creeping during assembly and maintains joint clamp load.



M6 prebulbed slotted body design incorporated under head wedges to increase the spin out resistance in soft plastic.



5/16-18 prebulbed slotted body style with a trimmed head. This head feature allowed installation in the field by the consumer or assembler when used with a special low cost installation tool. Feature also allows head to sit flush within a slot to prevent spin out.

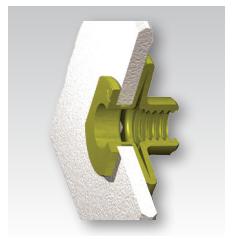

Closed end design with o-ring and o-ring recess under head provides the ultimate sealing solution for attachment points in applications with chemicals and other fluids that breakdown other sealing compounds.

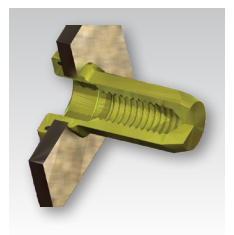

## SHEREX WEBSITE



- Complete product catalog featuring thousands of unique parts
- Engineering and sales drawings, sale sheets, pictures and full product specs available online or as a download for offline viewing.

**SHEREX  
WEBSITE  
AND 3D  
MODELS**

## 3D MODEL DOWNLOADS

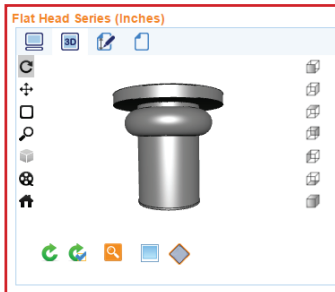
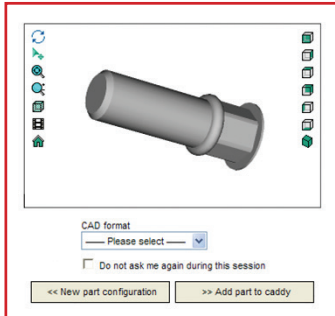

- Sherex utilizes Solidworks® 3D modeling to offer full customization and design capabilities to our customers. Simply click the button on our website to gain access to thousands of 3D models.
- Solidworks® enables customers to select parts based on style of interest, type of material, material thickness, open or closed end, and thread size.
- Once a customer has selected the required options, Solidworks® will create a 3D model of the fastener for placement into your modeling system.
- Models are available in 60 different formats, ranging from 3D XML to Universal 3D. Customers can view parts from any angle or perspective, and download CAD files for offline use.
- Models are available for Imperial/Inch body styles, Full Hex rivet nuts, RIV-FLOAT®, and Brass Inserts.
- Customers can directly request a quote from Sherex through the Solidworks site, and have a customer service rep follow up with them promptly to discuss their unique needs.

# SHEREX DECIMAL EQUIVALENTS & DRILL SIZE CHART

Drill Size	Inch (Dec.)	Metric (mm)	Drill Size	Inch (Dec.)	Metric (mm)	Drill Size	Inch (Dec.)	Metric (mm)	Drill Size	Inch (Dec.)	Metric (mm)	Drill Size	Inch (Dec.)	Metric (mm)
80	.0135	.343	50	.0700	1.778	22	.1570	3.988	G	.2610	6.630	31/64	.4844	12.304
79	.0145	.368	49	.0730	1.854	21	.1590	4.039	17/64	.2656	6.746	1/2	.5000	12.700
1/64	.0156	.396	48	.0760	1.930	20	.1610	4.089	H	.2660	6.756	33/64	.5156	13.096
78	.0160	.406	5/64	.0781	1.984	19	.1660	4.216	I	.2720	6.909	17/32	.5312	13.492
77	.0180	.457	47	.0785	1.994	18	.1695	4.305	J	.2770	7.036	35/64	.5469	13.891
76	.0200	.508	46	.0810	2.057	11/64	.1719	4.366	K	.2810	7.137	9/16	.5625	14.288
75	.0210	.533	45	.0820	2.083	17	.1730	4.394	9/32	.2812	7.142	37/64	.5781	14.684
74	.0225	.572	44	.0860	2.184	16	.1770	4.496	L	.2900	7.366	19/32	.5938	15.083
73	.0240	.609	43	.0890	2.261	15	.1800	4.572	M	.2950	7.493	39/64	.6094	15.479
72	.0250	.635	42	.0935	2.375	14	.1820	4.623	19/64	.2969	7.541	5/8	.6250	15.875
71	.0260	.660	3/32	.0938	2.383	13	.1850	4.700	N	.3020	7.671	41/64	.6406	16.271
70	.0280	.711	41	.0960	2.438	3/16	.1875	4.763	5/16	.3125	7.938	21/32	.6562	16.667
69	.0292	.742	40	.0980	2.489	12	.1890	4.801	O	.3160	8.026	43/64	.6719	17.066
68	.0310	.787	39	.0995	2.527	11	.1910	4.851	P	.3230	8.204	11/16	.6875	17.463
1/32	.0312	.792	38	.1015	2.578	10	.1935	4.915	21/64	.3281	8.334	45/64	.7031	17.859
67	.0320	.813	37	.104	2.642	9	.1960	4.978	Q	.3320	8.433	23/32	.7188	18.258
66	.330	.838	36	.1065	2.705	8	.1990	5.055	R	.3390	8.611	47/64	.7344	18.654
65	.0350	.889	7/64	.1094	2.779	7	.2010	5.105	11/32	.3438	8.733	3/4	.7500	19.050
64	.0360	.914	35	.1100	2.794	13/64	.2031	5.159	S	.3480	8.839	49/64	.7656	19.446
63	.0370	.940	34	.1110	2.819	6	.2040	5.182	T	.3580	9.093	25/32	.7812	19.842
62	.0380	.965	33	.1130	2.870	5	.2055	5.220	23/64	.3594	9.129	51/64	.7969	20.241
61	.0390	.991	32	.1160	2.946	4	.2090	5.309	U	.3680	9.347	13/16	.8125	20.638
60	.0400	1.016	31	.1200	3.048	3	.2130	5.410	3/8	.3750	9.525	53/64	.8281	21.034
59	.0410	1.041	1/8	.1250	3.175	7/32	.2188	5.558	V	.3770	9.576	27/32	.8438	21.433
58	.0420	1.067	30	.1285	3.264	2	.2210	5.613	W	.3860	9.804	55/64	.8594	23.829
57	.0430	1.092	29	.1360	3.454	1	.2280	5.791	25/64	.3906	9.921	7/8	.8750	22.225
56	.0465	1.181	28	.1405	3.569	A	.2340	5.944	X	.3970	10.084	57/64	.8906	22.621
3/64	.0469	1.191	9/63	.1406	3.571	15/64	.2344	5.954	Y	.4040	10.262	29/32	.9062	23.017
55	.0520	1.321	27	.1440	3.658	B	.2380	6.045	13/32	.4062	10.317	59/64	.9219	23.416
54	.0550	1.397	26	.1470	3.734	C	.2420	6.147	Z	.4130	10.490	15/16	.9375	23.813
53	.0595	1.511	25	.1495	3.797	D	.2460	6.248	27/64	.4219	10.716	61/64	.9531	24.209
1/16	.0625	1.588	24	.1520	3.861	1/4	.2500	6.350	7/16	.4375	11.113	31/32	.9688	24.608
52	.0635	1.613	23	.1540	3.912	E	.2500	6.350	29/64	.4531	11.509	63/64	.9844	25.004
51	.0670	1.702	5/32	.1562	3.967	F	.2570	6.528	15/32	.4688	11.908	1	1.000	25.400

No. of Gauge	Aluminum (B & S)	Steel (U.S. Std.)
10	0.101	0.1345
11	0.0907	0.1196
12	0.0808	0.1046
13	0.072	0.0897
14	0.0641	0.0747
15	0.0571	0.0673
16	0.0508	0.0598
17	0.0453	0.0538
18	0.0403	0.0478
19	0.0359	0.0418
20	0.0320	0.0359

No. of Gauge	Aluminum (B & S)	Steel (U.S. Std.)
21	0.0285	0.0329
22	0.0253	0.0299
23	0.0226	0.0269
24	0.0201	0.0239
25	0.0179	0.0209
26	0.0159	0.0179
27	0.0142	0.0164
28	0.0126	0.0149
29	0.0113	0.0135
30	0.0100	0.0120

Sherex also offers a variety of additional product lines to meet customer application requirements:

**ADDITIONAL  
SHEREX  
PRODUCT  
LINES**



### BRASS INSERTS

Brass inserts are ideal for fastening in plastics, as they provide a threaded hole where the base material is not strong enough to support a thread. Sherex's brass inserts are available in options including: ultrasonic, press-in, flanged, and molded-in, and have a self-aligning lead for accurate installation and mounting.



### CLINCH NUTS

Clinch nuts are ideal for fastening in high strength steels such as dual phase alloy, HSLA, and TRIPS, and meet class 10 nut strength requirements. Sherex's clinch nuts are designed to be used in any material that offers access from both sides of the base material.



### COMPRESSION LIMITERS

Compression limiters are ideal for fastening in plastics, as they protect the base material from cracking due to compressive loads generated when tightening the bolt. Sherex's compression limiters are custom engineered for specific applications and can be made with options including knurled and flanged.



### FASTENER AUTOMATION

Sherex combines world-class fastener design and manufacturing capabilities with industry-leading automation to offer a complete solution for customers' applications.

### TEC SERIES™



### WEDGE LOCKING WASHERS

TEC Series wedge locking washers are heavy duty, reusable, self-locking washers designed to secure safety-critical applications against vibrational loosening. Manufactured using stamping process. Available in carbon and stainless steel sizes M3-M72, #5-3". See TEC Series™ catalog for more details.

### DISC-LOCK™



### WEDGE LOCKING NUTS

Disc-Lock Wedge locking nuts are patented, heavy duty, self-locking nuts designed to protect joint integrity to secure safety critical applications against vibrational loosening. Available in sizes from M10 to M22, 3/8" to 7/8". See Disc-Lock catalog for more details.

### DISC-LOCK™

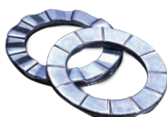

### WEDGE LOCKING WASHERS

Disc-Lock wedge locking washers are heavy duty, self-locking washers designed to secure safety-critical applications against vibrational loosening. Ideal for applications where reusability is not required. Manufactured using scrapless cold-forming technology. Available in Carbon Steel sizes M3-M38, #6- 1 1/1 and in stainless steel sizes M6-M24, 1/4"-1". See Disc-Lock catalog for more details.



**HEADQUARTERS:**

**SHEREX FASTENING SOLUTIONS, LLC**

400 Riverwalk Pkwy, Suite 600  
Tonawanda, NY 14150  
Phone: 866-474-3739  
Fax: 716-875-0358  
E-mail: info@sherex.com  
www.sherex.com

**PRODUCTION FACILITIES:**

**SHEREX AKRON**

850 Moe Drive  
Akron, OH 44310  
Phone: 330-630-2293  
Fax: 716-875-0358

**SHEREX TAIWAN**

No. 201, Sandong Road  
Chungli City  
Taoyuan District, Taiwan 32053  
Phone: +886 3-498-8689  
Fax: +886 3-498-3543  
E-mail: sales@sherex.com.tw

**ADDITIONAL LOCATIONS:**

**SHEREX MEXICO S. DE R.L. DE C.V.**

Circuito Balvanera 5A Bodega 11  
Parque Industrial Balvanera  
Corregidora, Queretaro  
C.P. 76900 Mexico  
Phone: +52 (442) 196-8354  
E-mail: sales@sherexmexico.com



**SUPPLIED TO YOU BY:**



ALL INFORMATION IN THIS CATALOG IS SUBJECT TO CHANGE WITHOUT NOTICE.

