



SHEREX FASTENING SOLUTIONS

Fastening Systems Engineered For Performance™

TECSERIES™



WEDGE LOCKING WASHERS



HOW DOES IT WORK?

TEC Series washers secure joints using tension rather than friction, as with traditional locking fasteners. TEC washers consist of a pair of washers with cams on one side and radial teeth on the other. The cam sides are joined together with a mild adhesive, and installed between the bolt head and/or nut and the joint material.

During installation, the radial teeth cause one half of the washer to be seated to the bolt or nut, while the other half is seated to the joint material.

When exposed to load or vibration, the bolt or nut will attempt to loosen. Since the radial teeth are seated to the mating surfaces, any movement in the loosening direction is forced between the cam.

Because the cam angle (α) of the washers is greater than the thread pitch angle (β) of the bolt, a wedge effect is created by the cams, preventing the bolt or nut from rotating loose. Clamp load is maintained and the joint remains secure.

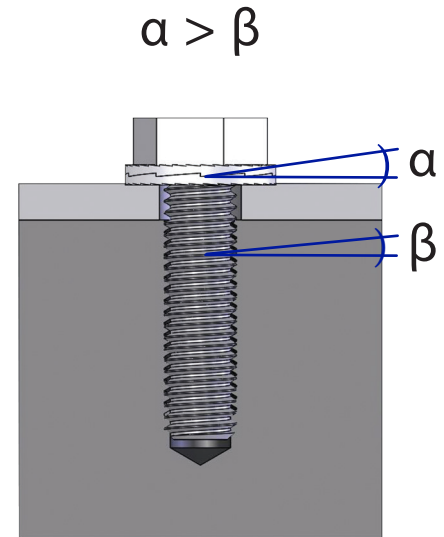

FEATURES AND BENEFITS

- Maintains clamp load in high vibration and load applications, thereby protecting the security of the joint
- Heavy duty, self-locking design
- For use with bolts up to Class 12.9, Grade 8
- Sizes from #8 (M4) to 1 3/8" (M36) in stock, available for immediate shipment
- Available in SCM435 Alloy Steel, 316L Stainless Steel, and 254 SMO Stainless Steel
- Provided in preassembled glued pairs
- Easy to install and remove with standard tools
- No retightening needed after installation
- **Reusable - will not distort threads on bolt**
- Vibration proof according to MIL-STD-1312-7/DIN 25201
- Lubrication does not impair the locking function of the washer
- Can be used reliably for joints with short clamp length
- Secures joints with high and low preloads

TECSERIES™



INSTALLATION

- To install the TEC Series washer, place the preassembled pair between the nut and/or bolt and the joint material. See page 4 for application examples.
- As the nut or bolt is tightened, one half of the washer pair will be seated to the joint material and the other half will be seated to the nut or bolt.
- Tighten joints with TEC Series washers using standard tools. Retightening is not needed.
- The use of lubricants is highly recommended when installing TEC Series washers. A high quality lubricant designed to prevent seizing will reduce friction during installation and improve the consistency of clamp load in joints.
- When installing TEC Series washers in a common application, expect an increase in required torque over recommended installation torque to achieve proper clamp load and maximum joint safety. See Torque Guidelines on page 3 for more information.



REMOVAL AND REUSE

Removing TEC Series washers requires no special tools or procedure. Simply loosen the joint in the normal method and check the washer to ensure cam faces disengage.

While TEC Series washers are typically reusable, washers should always be inspected for deformation or excessive wear before reuse. If washers appear deformed or heavily worn, discard and use a new pair.

QUALITY

Each Sherex manufacturing facility is led by a team of seasoned engineering professionals charged with ensuring all products meet stringent quality requirements. Our facilities are certified to AS9100, ISO 9001:2008, ISO 14001, ISO/TS 16949, and ISO 17025, and utilize world-class testing equipment, including tensile testing, accelerated corrosion salt spray testing machines, torque testing, standard measurement and gauging equipment, and optical sorting machines.

TEC Series Washers are manufactured in a facility which strictly adheres to multiple ISO certification standards, and are thoroughly tested through the production cycle to ensure a high level of quality. All TEC Series products are fully RoHS compliant.



TECSERIES™



PROVEN RESULTS

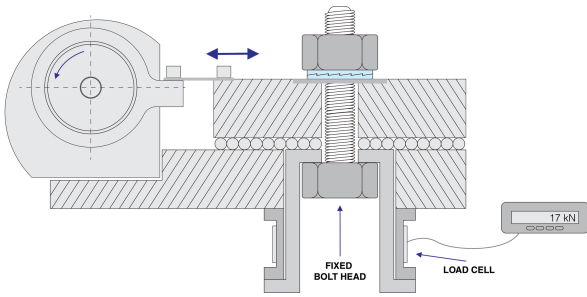

TEC Series wedge locking washers have been tested on a Junker Vibration Machine. The Junker test, according to DIN 65151, considered the most severe vibration test for bolted joints, is used to determine the point at which a bolted joint loses its preload when subjected to shear loading due to transverse vibration.

When tested against other product options using the Junker test, TEC Series washers remained secure while all other products loosened significantly.

TEC SERIES JUNKER TEST

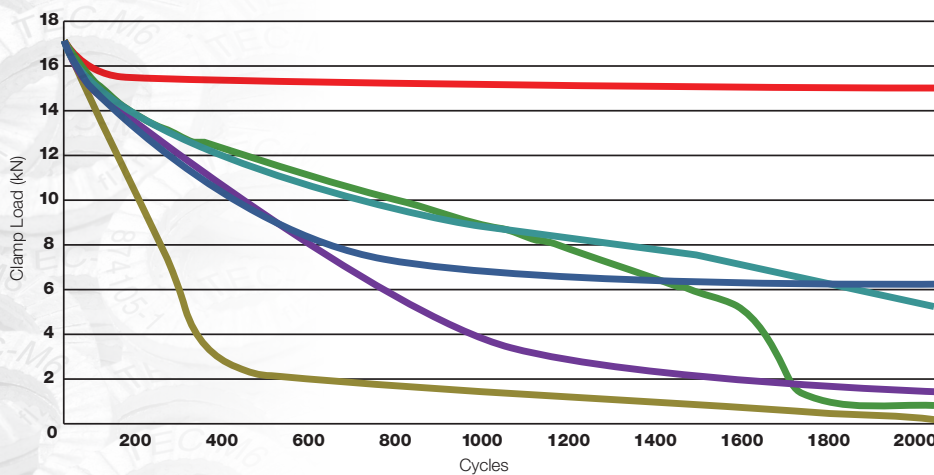

- TEC Series Washer
- Split Lock Washer
- Mechanical Lock Nut
- Nylon Insert Nut
- Hex Nut, No Washer
- Hex Nut, Flat Washer

All options were tested with 1.0 MM amplitude at 12.5 Hz for 2000 cycles. See Sherex website for additional testing data.

Our in-house engineering staff can provide specific testing for customer applications. Contact Sherex.

TORQUE GUIDELINES

TORQUE TEST RESULTS TEC SERIES STEEL M10 WASHERS

		PITCH (MM)	TORQUE (Nm)	CLAMP LOAD (kN)
M10 Class 8.8 Bolt Zinc Plated	Lubricated	1.5	52	27.0
	Dry	1.5	52	19.8
M10 Class 10.9 Bolt Zinc Plated	Lubricated	1.5	66	38.5
	Dry	1.5	66	28.8
M10 Class 10.9 Bolt Zinc Flake	Lubricated	1.5	77	38.5
	Dry	1.5	77	36.7

The goal of a fastened joint is to maintain clamp load. The chart to the left highlights the effects of lubrication on achieving desired clamp load.

For the lubricated test conditions, bolts were coated with Molykote® 1000. Torque data is based on achieving clamp loads at 80% of proof load for both Class 8.8 and Class 10.9 bolts, according to ISO 898-1.

Corresponding Class 8.8 and 10.9 bolts were tightened to the same torque as the previous test, with lubrication omitted from the joint.

Class 10.9 bolts with zinc flake coating were also tested, with and without lubrication, to demonstrate the effect of coating on required installation torque.

Sherex recommends bolt-joint lubrication for consistent joint performance when using TEC Series washers.

Due to varying installation conditions and customer specific applications, additional information and torque recommendations are available by contacting Engineering support at Sherex.



TECSERIES™

APPLICATION EXAMPLES

TEC Series wedge locking washers can be used to protect joint integrity in a wide variety of joint types, including:

Tapped Hole

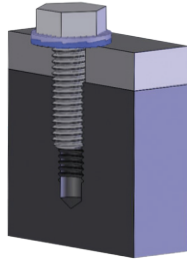

- Effectively secures bolt head to mating surface.

Counter Bore

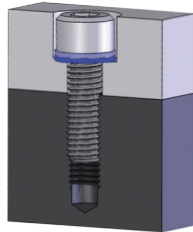

- TEC Series washers are designed to fit under the head of socket products in counter bore holes.

Stud Bolt

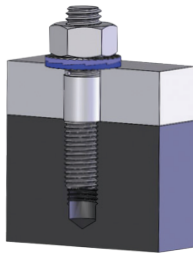

- Securely fastens nut in stud bolt applications eliminating the need for adhesives.

Slotted or Large Hole

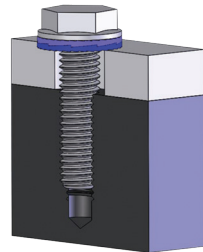

- TEC Series LD washers are suited for use under flange bolts and nuts and to optimize the clamp load across large or slotted holes and soft mating surfaces.

Through Hole

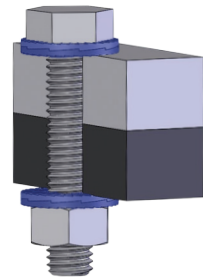

- Through hole applications require TEC Series washers under the bolt head and nut to maintain joint security.



Not Recommended

TEC Series wedge locking washers are not recommended for:

- Mating surfaces together that are free to rotate or move
- Mating surfaces that are harder than the washers
- Use in non-preloaded joints
- Very soft base material, such as wood

TECSERIES™

SHEREX FASTENING SOLUTIONS®

SPECIFICATIONS & ORDERING INFORMATION

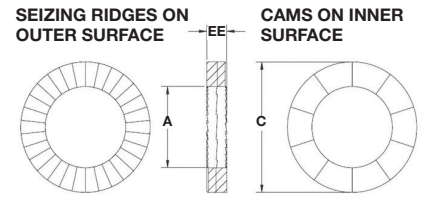

ALLOY STEEL WASHER

PART #	BOLT SIZE		STANDARD DIMENSIONS (INCHES)			METRIC DIMENSIONS (MILLIMETERS)			BOX QUANTITY
	INCHES	METRIC	INNER DIAMETER(A)	OUTER DIAMETER(C)	THICKNESS(EE)	INNER DIAMETER(A)	OUTER DIAMETER(C)	THICKNESS(EE)	
TEC-M3	#5	M3	0.134	0.276	0.071	3.4	7.0	1.8	200
TEC-M3.5	#6	M3.5	0.154	0.299	0.071	3.9	7.6	1.8	200
TEC-M4	#8	M4	0.173	0.299	0.071	4.4	7.6	1.8	200
TEC-M5	#10	M5	0.213	0.354	0.071	5.4	9.0	1.8	200
TEC-M6		M6	0.256	0.425	0.071	6.5	10.8	1.8	200
TEC-1/4	1/4		0.283	0.453	0.098	7.2	11.5	2.5	200
TEC-M8	5/16	M8	0.343	0.531	0.098	8.7	13.5	2.5	200
TEC-3/8	3/8		0.406	0.654	0.098	10.3	16.6	2.5	200
TEC-M10		M10	0.421	0.654	0.098	10.7	16.6	2.5	200
TEC-M11	7/16	M11	0.449	0.728	0.098	11.4	18.5	2.5	200
TEC-M12		M12	0.512	0.768	0.098	13.0	19.5	2.5	200
TEC-1/2	1/2		0.531	0.768	0.098	13.5	19.5	2.5	200
TEC-M14	9/16	M14	0.598	0.906	0.134	15.2	23.0	3.4	100
TEC-M16	5/8	M16	0.669	1.000	0.134	17.0	25.4	3.4	100
TEC-M18		M18	0.768	1.142	0.134	19.5	29.0	3.4	100
TEC-3/4	3/4		0.787	1.209	0.134	20.0	30.7	3.4	100
TEC-M20		M20	0.843	1.209	0.134	21.4	30.7	3.4	100
TEC-M22	7/8	M22	0.921	1.358	0.134	23.4	34.5	3.4	100
TEC-M24		M24	0.996	1.535	0.134	25.3	39.0	3.4	100
TEC-1	1		1.098	1.535	0.134	27.9	39.0	3.4	100
TEC-M27		M27	1.118	1.654	0.228	28.4	42.0	5.8	50
TEC-M30	1 1/8	M30	1.236	1.850	0.228	31.4	47.0	5.8	50
TEC-M33	1 1/4	M33	1.354	1.909	0.228	34.4	48.5	5.8	25
TEC-M36	1 3/8	M36	1.472	2.165	0.228	37.4	55.0	5.8	25
TEC-M39	1 1/2	M39	1.591	2.303	0.228	40.4	58.5	5.8	25
TEC-M42		M42	1.701	2.480	0.228	43.2	63.0	5.8	25
TEC-M45	1 3/4	M45	1.819	2.756	0.276	46.2	70.0	7.0	25
TEC-M48		M48	1.953	2.953	0.276	49.6	75.0	7.0	25
TEC-M52	2	M52	2.110	3.150	0.276	53.6	80.0	7.0	25
TEC-M56	2 1/4	M56	2.327	3.346	0.276	59.1	85.0	7.0	10
TEC-M60		M60	2.484	3.543	0.276	63.1	90.0	7.0	10
TEC-M64	2 1/2	M64	2.642	3.740	0.276	67.1	95.5	7.0	10
TEC-M68		M68	2.799	3.937	0.374	71.1	100.0	9.5	1
TEC-M72		M72	2.957	4.134	0.374	75.1	105.0	9.5	1

Weight and thickness of pairs will vary slightly with gauge of metal.
Made of SCM 435 Steel.

- Coated in Delta Protekt® KL100 and V H302 GZ, protection to 600 hours salt spray. Other coatings available; please contact Sherex for more information.

DIMENSIONAL TOLERANCES FOR ALL MATERIALS AND STYLES

STANDARD								METRIC							
INNER DIAMETER(A)			OUTER DIAMETER(C)			THICKNESS(EE)		INNER DIAMETER(A)			OUTER DIAMETER(C)			THICKNESS(EE)	
M3-M8	M10-M42	M45-M72	M3-M24	M27-M42	M45-M72	M3-M42	M45-M72	M3-M8	M10-M42	M45-M72	M3-M24	M27-M42	M45-M72	M3-M42	M45-M72
± 0.004	± 0.008	+ 0.02 / -0.00	± 0.008	± 0.012	+ 0.000 / -0.080	± 0.010	± 0.030	± 0.1	± 0.2	+ 0.5 / -0.0	± 0.2	± 0.3	+ 0.0 / -2.0	± 0.25	± 0.75

SPECIFICATIONS & ORDERING INFORMATION

STAINLESS STEEL WASHER

PART #	BOLT SIZE		STANDARD DIMENSIONS (INCHES)			METRIC DIMENSIONS (MILLIMETERS)			BOX QUANTITY
	INCHES	METRIC	INNER DIAMETER(A)	OUTER DIAMETER(C)	THICKNESS(EE)	INNER DIAMETER(A)	OUTER DIAMETER(C)	THICKNESS(EE)	
TEC-M3ss	#5	M3	0.134	0.276	0.087	3.4	7.0	2.2	200
TEC-M3.5ss	#6	M3.5	0.154	0.299	0.087	3.9	7.6	2.2	200
TEC-M4ss	#8	M4	0.173	0.299	0.087	4.4	7.6	2.2	200
TEC-M5ss	#10	M5	0.213	0.354	0.087	5.4	9.0	2.2	200
TEC-M6ss		M6	0.256	0.425	0.087	6.5	10.8	2.2	200
TEC-1/4ss	1/4		0.283	0.453	0.087	7.2	11.5	2.2	200
TEC-M8ss	5/16	M8	0.343	0.531	0.079	8.7	13.5	2.0	200
TEC-3/8ss	3/8		0.406	0.654	0.079	10.3	16.6	2.0	200
TEC-M10ss		M10	0.421	0.654	0.079	10.7	16.6	2.0	200
TEC-M11ss	7/16	M11	0.449	0.728	0.087	11.4	18.5	2.2	200
TEC-M12ss		M12	0.512	0.768	0.079	13.0	19.5	2.0	200
TEC-1/2ss	1/2		0.531	0.768	0.079	13.5	19.5	2.0	200
TEC-M14ss	9/16	M14	0.598	0.906	0.118	15.2	23.0	3.0	100
TEC-M16ss	5/8	M16	0.669	1.000	0.118	17.0	25.4	3.0	100
TEC-M18ss		M18	0.768	1.142	0.126	19.5	29.0	3.2	100
TEC-3/4ss	3/4		0.787	1.209	0.126	20.0	30.7	3.2	100
TEC-M20ss		M20	0.843	1.209	0.118	21.4	30.7	3.0	100
TEC-M22ss	7/8	M22	0.921	1.358	0.126	23.4	34.5	3.2	100
TEC-M24ss		M24	0.996	1.535	0.126	25.3	39.0	3.2	100
TEC-1ss	1		1.098	1.535	0.126	27.9	39.0	3.2	100
TEC-M27ss		M27	1.118	1.654	0.268	28.4	42.0	6.8	50
TEC-M30ss	1 1/8	M30	1.236	1.850	0.268	31.4	47.0	6.8	50
TEC-M33ss	1 1/4	M33	1.354	1.909	0.268	34.4	48.5	6.8	25
TEC-M36ss	1 3/8	M36	1.472	2.165	0.268	37.4	55.0	6.8	25
TEC-M39ss	1 1/2	M39	1.591	2.303	0.268	40.4	58.5	6.8	25
TEC-M42ss		M42	1.701	2.480	0.268	43.2	63.0	6.8	25
TEC-M45ss	1 3/4	M45	1.819	2.756	0.268	46.2	70.0	6.8	25
TEC-M48ss		M48	1.953	2.953	0.268	49.6	75.0	6.8	25
TEC-M52ss	2	M52	2.110	3.150	0.354	53.6	80.0	9.0	1
TEC-M56ss	2 1/4	M56	2.327	3.346	0.354	59.1	85.0	9.0	1
TEC-M60ss		M60	2.484	3.543	0.354	63.1	90.0	9.0	1
TEC-M64ss	2 1/2	M64	2.642	3.740	0.354	67.1	95.5	9.0	1
TEC-M68ss		M68	2.799	3.937	0.354	71.1	100.0	9.0	1
TEC-M72ss		M72	2.957	4.134	0.354	75.1	105.0	9.0	1

Made of 316L Stainless Steel.

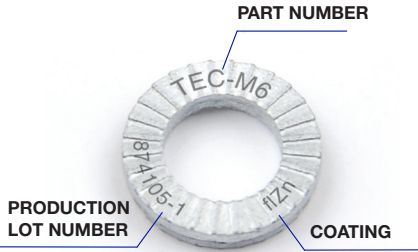

PRODUCT LASER ETCHING CODE

WASHER TYPE	CODE
STEEL, DELTA PROTEKT®	flZn
STAINLESS STEEL	SS

TRACEABILITY

TEC Series washers are produced in fully documented production lots, and are laser etched with the production lot number to provide full traceability.

To allow for easy identification, each part also has the part number (and size) and coating or material etched onto it.

TECSERIES™

Custom designs available. Contact Sherex for more information.



SPECIFICATIONS & ORDERING INFORMATION

TEC Series LD washers have a larger outer diameter, and are ideal for use in large or slotted hole applications, with soft or painted mating surfaces, and with flanged bolts and nuts.

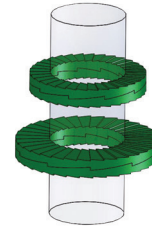

STANDARD OUTER DIAMETER

LARGE OUTER DIAMETER (LD)

LARGE DIAMETER ALLOY STEEL WASHER

PART #	BOLT SIZE		STANDARD DIMENSIONS (INCHES)			METRIC DIMENSIONS (MILLIMETERS)			BOX QUANTITY
	INCHES	METRIC	INNER DIAMETER(A)	OUTER DIAMETER(C)	THICKNESS(EE)	INNER DIAMETER(A)	OUTER DIAMETER(C)	THICKNESS(EE)	
TEC-M3.5LD	#6	M3.5	0.154	0.354	0.071	3.9	9.0	1.8	200
TEC-M4LD	#8	M4	0.173	0.354	0.071	4.4	9.0	1.8	200
TEC-M5LD	#10	M5	0.213	0.425	0.071	5.4	10.8	1.8	200
TEC-M6LD		M6	0.256	0.531	0.098	6.5	13.5	2.5	200
TEC-1/4LD	1/4		0.283	0.531	0.098	7.2	13.5	2.5	200
TEC-M8LD	5/16	M8	0.343	0.654	0.098	8.7	16.6	2.5	200
TEC-3/8LD	3/8		0.406	0.827	0.098	10.3	21.0	2.5	200
TEC-M10LD		M10	0.421	0.827	0.098	10.7	21.0	2.5	200
TEC-M12LD		M12	0.512	1.000	0.134	13.0	25.4	3.4	100
TEC-1/2LD	1/2		0.531	1.000	0.134	13.5	25.4	3.4	100
TEC-M14LD	9/16	M14	0.598	1.209	0.134	15.2	30.7	3.4	100
TEC-M16LD	5/8	M16	0.669	1.209	0.134	17.0	30.7	3.4	100
TEC-M18LD		M18	0.768	1.358	0.134	19.5	34.5	3.4	100
TEC-3/4LD	3/4		0.787	1.535	0.134	20.0	39.0	3.4	100
TEC-M20LD		M20	0.843	1.535	0.134	21.4	39.0	3.4	100
TEC-M22LD	7/8	M22	0.921	1.654	0.181	23.4	42.0	4.6	50
TEC-M24LD		M24	0.996	1.909	0.181	25.3	48.5	4.6	50
TEC-1LD	1		1.098	1.909	0.181	27.9	48.5	4.6	50
TEC-M27LD		M27	1.118	1.909	0.228	28.4	48.5	5.8	25
TEC-M30LD	1 1/8	M30	1.236	2.303	0.260	31.4	58.5	6.6	25
TEC-M33LD	1 1/4	M33	1.354	2.303	0.260	34.4	58.5	6.6	25
TEC-M36LD	1 1/2	M36	1.472	2.480	0.260	37.4	63.0	6.6	25

Weight and thickness of pairs will vary slightly with gauge of metal.
Made of SCM 435 Steel.

LARGE DIAMETER STAINLESS STEEL WASHER

PART #	BOLT SIZE		STANDARD DIMENSIONS (INCHES)			METRIC DIMENSIONS (MILLIMETERS)			BOX QUANTITY
	INCHES	METRIC	INNER DIAMETER(A)	OUTER DIAMETER(C)	THICKNESS(EE)	INNER DIAMETER(A)	OUTER DIAMETER(C)	THICKNESS(EE)	
TEC-M3.5LDss	#6	M3.5	0.154	0.354	0.087	3.9	9.0	2.2	200
TEC-M4LDss	#8	M4	0.173	0.354	0.087	4.4	9.0	2.2	200
TEC-M5LDss	#10	M5	0.213	0.425	0.087	5.4	10.8	2.2	200
TEC-M6LDss		M6	0.256	0.531	0.079	6.5	13.5	2.0	200
TEC-1/4LDss	1/4		0.283	0.531	0.087	7.2	13.5	2.2	200
TEC-M8LDss	5/16	M8	0.343	0.654	0.079	8.7	16.6	2.0	200
TEC-3/8LDss	3/8		0.406	0.827	0.079	10.3	21.0	2.0	200
TEC-M10LDss		M10	0.421	0.827	0.079	10.7	21.0	2.0	200
TEC-M12LDss		M12	0.512	1.000	0.118	13.0	25.4	3.0	100
TEC-1/2LDss	1/2		0.531	1.000	0.126	13.5	25.4	3.2	100
TEC-M14LDss	9/16	M14	0.598	1.209	0.126	15.2	30.7	3.2	100
TEC-M16LDss	5/8	M16	0.669	1.209	0.126	17.0	30.7	3.2	100
TEC-M18LDss		M18	0.768	1.358	0.126	19.5	34.5	3.2	100
TEC-3/4LDss	3/4		0.787	1.535	0.126	20.0	39.0	3.2	100
TEC-M20LDss		M20	0.843	1.535	0.126	21.4	39.0	3.2	100
TEC-M22LDss	7/8	M22	0.921	1.654	0.126	23.4	42.0	3.2	50
TEC-M24LDss		M24	0.996	1.909	0.126	25.3	48.5	3.2	50
TEC-1LDss	1		1.098	1.909	0.126	27.9	48.5	3.2	50
TEC-M27LDss		M27	1.118	1.909	0.268	28.4	48.5	6.8	25
TEC-M30LDss	1 1/8	M30	1.236	2.303	0.268	31.4	58.5	6.8	25

Made of 316L Stainless Steel.

TECSERIES™

Custom designs available. Contact Sherex for more information.



PROVEN APPLICATIONS



Agriculture & Construction Equipment

Challenge: When joints fail, performing corrective maintenance in the field - often requiring disassembling and reassembling complex machinery - is difficult and time consuming.

TEC Series Washers withstand the vibration and load associated with the agriculture and construction conditions, and hold joints secure.



Power Generation

Challenge: Due to windy conditions, bolted joints in these applications can experience severe vibration, causing joint failure in remote, hard-to-reach locations. Getting maintenance resources to remote locations to fix joints can be costly and dangerous.

TEC Series Washers withstand vibration due to windy conditions, eliminating the need for costly and dangerous repairs.



Gas & Oil

Challenge: Keeping joints secure in safety critical and harsh operating environments such as oil rigs can be dangerous, and joints are often found in hard-to-reach locations.

TEC Series Washers are created to withstand harsh operating environments, and will keep joints secure without needing replacements or extensive maintenance.



Mining

Challenge: In this harsh work environment, where equipment is subjected to extreme vibration, joints can fail, causing costly equipment downtime in remote locations.

TEC Series Washers' proven wedge locking technology protects joints under severe vibration, and can eliminate machine downtime.



General Machinery Manufacturing

Challenge: In safety-critical environments such as roller-coasters, guaranteeing that joints do not fail is paramount; performing extensive maintenance and performance checks can be costly and inconvenient.

TEC Series Washers have been proven in Junker's tests to hold joints under severe vibration.

TECSERIES™

SHEREX FASTENING SOLUTIONS®

ABOUT SHEREX

Sherex Fastening Solutions has a proven history of providing innovative, engineered solutions for securing joints. Sherex Industries was founded in 1979 in Buffalo, NY, primarily serving the Automotive and Fluid Power markets. In 2004, the rivet nut division was spun off, and became Sherex Fastening Solutions. Throughout our 35+ year history, we've remained steadfast in our mission to deliver high quality fastening solutions at the lowest total installed cost. We've expanded and improved our offerings and services by creating proprietary products, forming strategic alliances, and establishing world-class production facilities and customer support centers in Taiwan, Mexico, and Akron, Ohio.

Sherex's comprehensive product offering includes: Standard Rivet Nuts, Custom Rivet nuts, MS/NAS Rivet Nuts, Rivet Nut Installation Tools, Compression Limiters, Clinch Nuts, Brass Inserts, Fastener automation equipment, and Disc-Lock Wedge Locking Washers and Nuts.

Our engineering-focused team is comprised of manufacturing engineers, application engineers, and technical sales professionals that are dedicated to exceeding our customers' needs by collaborating to create customized, application-specific solutions.

GLOBAL PRESENCE

Sherex provides service and support to our customers around the world through a network of sales offices, technical support centers, distribution hubs, and manufacturing facilities. We are a partner in the A-FAS group, a consortium of 9 companies across Europe, Asia, and North America that work together to provide a comprehensive range of products, tools, automation, and customer support worldwide to our customers. Contact us if you would like one of our fastening experts to assist you in solving your fastening challenges.

AUTORIV®

MDS
Fastening
Systems

SHEREX
HEADQUARTERS
TONAWANDA, NY

SHEREX
AKRON

SHEREX
MEXICO



 DEJOND
METAL MATTERS

SHEREX
TAIWAN

SHEREX FASTENING SOLUTIONS®

 TEC SERIES™

SHEREX PRODUCT SHOWCASE

Sherex is committed to providing customers with the lowest total installed cost fastening solutions for a wide variety of applications. Here are some of our product lines:

BLIND RIVET NUTS



Sherex blind rivet nuts provide load bearing threads in thin sheet materials that are too thin for a tapped thread. Blind rivet nuts are also used when an application has little or no access to the backside as they can be installed from the front side of the work piece. Sherex offers standard and custom rivet nuts, and these additional rivet nut products:

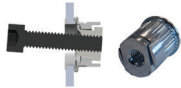

RIV-FLOAT® RIVET NUTS

RIV-FLOAT® was developed for easy, accurate, and fast attachment of components in off center applications. RIV-FLOAT® Accounts for tolerance stack up in joint design and misalignment during the service of the joint. RIV-FLOAT®-SHORT is available for applications requiring backside clearance similar to that of various riveted nut plates and cage nuts.



FULL HEX RIVET NUTS

Sherex full hex rivet nuts provide increased spin out resistance over round or half hex body styles. These products are compatible with Class 8, Grade 5 hardware, and are available in sizes 1/4-20 to 1/2-13 and M6 to M12 in small flange and large flange styles.



LARGE SIZE RIVET NUTS

Sherex Large Size rivet nuts are offered in sizes from 3/4 -10 and M16. These rivet nuts were developed for applications where critical joint performance and high tensile loads are required.



NAS AND MS RIVET NUTS

Sherex NAS and MS rivet nuts are ideal for aerospace and defense applications that require NAS 1329, NAS 1330, and MS27130 standards. All styles are manufactured in our AS9100-certified Akron, Ohio facility, and are available in steel, aluminum, 430 stainless steel, 316 stainless steel, alloy steel, and brass. Cage Codes 7EK30 & 4JQL4.



RIVET NUT INSTALLATION TOOLS

Sherex offers a broad line of installation tools, from hand tools ideal for prototyping and small volumes to hydro-pneumatic tools ideal for large production runs.



IN-DIE AUTOMATION

Sherex, with our partner, Autoriv®, offers custom-engineered fastener automation equipment for specific budgets and performance requirements.



CLINCH NUTS

Sherex offers several varieties of clinch nuts, ideal for fastening in high strength steels where access to both sides of the base material is available that have class 10 nut strength requirements.



BRASS INSERTS

Sherex brass inserts are ideal for fastening in plastics, as they provide a threaded hole when the base material is not strong enough to support a thread.



COMPRESSION LIMITERS

Compression limiters are ideal for use in plastics, as they protect the base material from cracking due to compressive loads generated when tightening bolts. Sherex compression limiters are custom engineered for specific applications.

DISC-LOCK™



WEDGE LOCKING NUTS

Disc-Lock wedge locking nuts are patented, heavy duty, self-locking nuts designed to maintain joint integrity in high vibration applications. Available in sizes from M10 to M22, 3/8" to 7/8".



WEDGE LOCKING WASHERS

Disc-Lock wedge locking washers are heavy duty, self-locking washers designed to secure safety-critical applications against vibrational loosening. Ideal for situations where reusability is not required. Manufactured using scrapless cold-forming technology. Available in carbon steel sizes M3-M38, #6-1 1/2" and in stainless steel sizes M6-M24, 1/4"-

Please contact Sherex for more information on any of these product lines.

SHEREX HEADQUARTERS

400 Riverwalk Pkwy, Suite 600
Tonawanda, NY 14150
Phone: 866-474-3739
Fax: 716-875-0358
E-mail: info@sherex.com
www.sherex.com

SHEREX AKRON

850 Moe Drive
Akron, OH 44310
Phone: 234-205-1178

SHEREX TAIWAN

No 201, Sandong Road, Chungli Dist,
Taoyuan City, 32053, Taiwan R.O.C.
Taoyuan District, Taiwan 32053
Phone: +886 3-498-8689
Fax: +886 3-498-3543
E-mail: sales@sherex.com.tw

SHEREX MEXICO

Circuito Balvanera 5A Bodega 11
Parque Industrial Balvanera
Corregidora, Queretaro
C.P. 76900 Mexico
Phone: +52 (442) 196-8354
E-mail: sales@sherexmexico.com

**Ask About Our
MADE IN THE U.S.A.
Product Line**

TEC-C 11-2017

TECSERIES™



info@sherex.com | 866.474.3739 | sherex.com/tec-series